



1080p60 Video Server ANT-35000H

H.264 Encoder HDMI in and out



User Manual ver.3.0

Support can be found at :

<https://antrica.freshdesk.com/support/home>

Safety Precaution

**We appreciate your purchasing video server.
Before installing the product, please read the following with care.**

- ◇ Make sure to turn off the power before installing video server.
- ◇ Do not install under the direct sunlight or in dusty areas.
- ◇ Make sure to use the product within the temperature and humidity specified in the specification.
- ◇ Do not operate the product in presence of vibrations or strong magnetic fields.
- ◇ Do not put electrically conducting materials in the ventilation hole.
- ◇ Do not open the top cover of the products. It may cause a failure or electric shock on the components.
- ◇ To prevent from overheating, make sure to keep the distance at least 10cm from the ventilation hole.
- ◇ Make sure proper voltage before connecting the power.

Table of Content

1. Introduction.....	4
About this manual	4
Features	4
Product and Accessories.....	5
System Connections	8
2. Installation	10
3. System Operation.....	13
•Remote Video Monitoring	13
re-initialisation of IP Address.....	16
4. Remote Configuration	17
•Using the Web Browser	17
•Video & Audio	18
•Image	24
•Network.....	26
•Event.....	42
•Record	46
•Device	52
•PTZ	53
•User	57
•System.....	59

1. Introduction

About this manual

This User Manual provides information on installation setup and operation of the video server, as well as troubleshooting tips. .

Features

Video server is a video and audio transmission system that provides broadcast quality audio and video, based on an IP network through LAN and ADSL/VDSL. vThe Vdeo server can operate in an Encoder mode. Encoder system compresses media data and transmits it.

Video

- Up to 1920x1080 @ 60 fps
- Quad Streams
- Highly efficient compression algorithm, H.264 & MJPEG support
- Wide range of transmission rates: 32kbps ~ 16mbps
- Various transmission modes: CBR, VBR
- Motion detection

Audio

- Multi-Transmission Mode : Unidirectional Mode (IP-server to Client PC or Decoder / Client PC or Decoder to IP-server), Bi-directional Mode

Network

- Fixed IP & Dynamic IP (DHCP) support
- 1:1, 1:N support
- Multicasting
- Automatic transmit rate control according to network conditions
- OnVIF, PSIA compliant

Serial Data

- RS-485 support
- Data pass-through mode : Serial data communication between IP camera and Decoder
- Data pass-through mode : Serial data communication between Encoder - Decoder

Sensor and Alarm

- Support direct connections of external sensor and alarm devices
- Event Alarm

USB

- Connection to internal or external USB storage for remote access, recording and playback

User Interface

- Diagnose and upgrade through dedicated program called True Manager
- System configuration using Internet Explorer

High Reliability

- Reliable embedded system
- System recovery by dual watch-dog functions

Product and Accessories



video server



Quick Manual

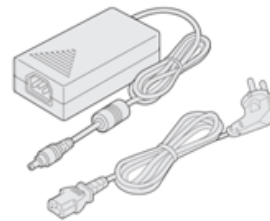

Power adapter and Cable



**Power Cord UK
USA EU**



Screws

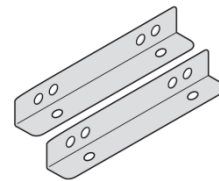

Brackets

• Part Names and Functions

Front View

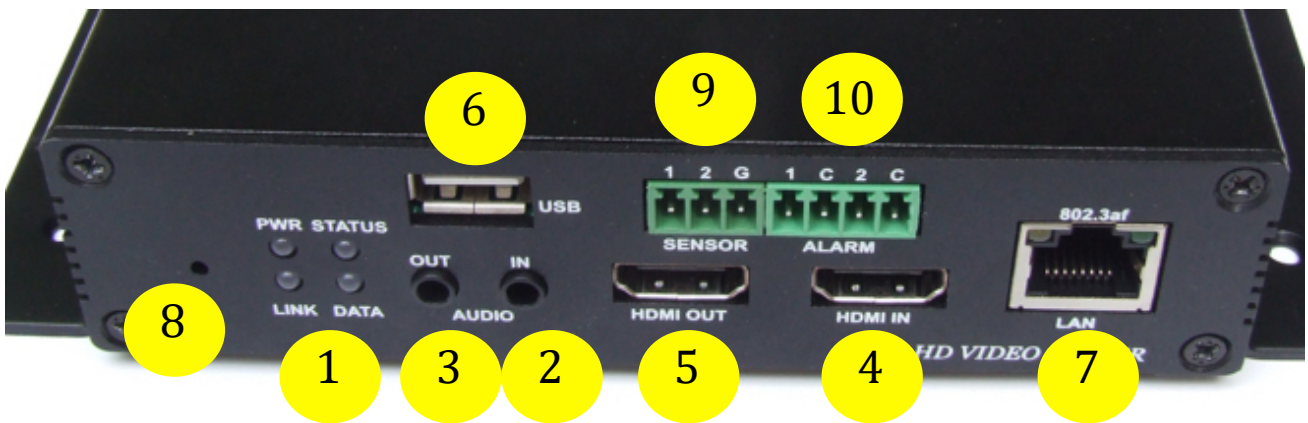

No.	Parts	Function
①	LED	Display system status
②	Audio Input	Audio Input
③	Audio Output	Audio Output
④	HDMI Input	HDMI Video & Audio Input
⑤	HDMI Output	HDMI Video & Audio Output
⑥	USB Port	USB 2.0
⑦	Ethernet/802.3af	1000/100/10MB Base-T Ethernet
⑧	Reset Button	Initialization of network setting
⑨	Sensor	Sensor Input
⑩	Alarm	Alarm or Relay Output

Rear View

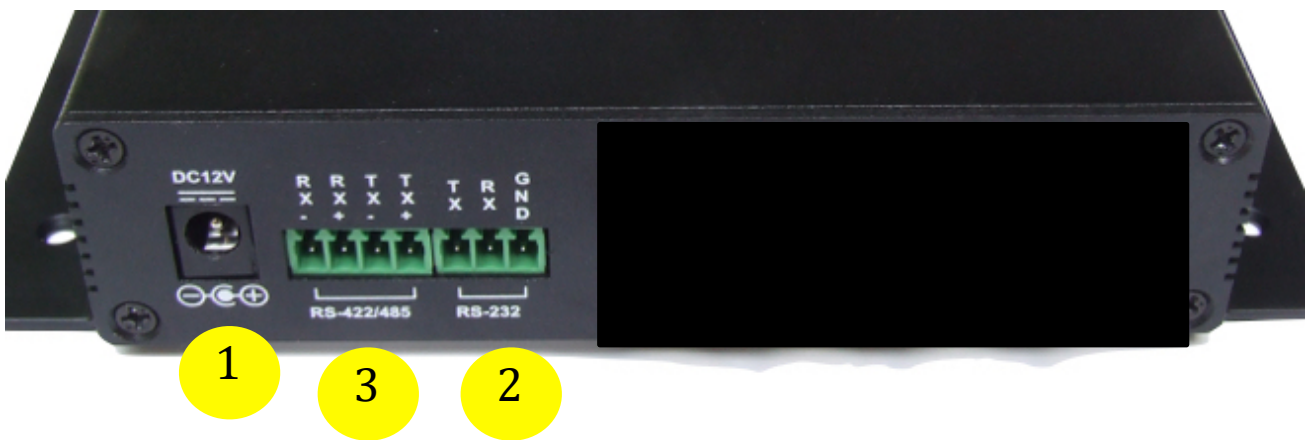

No.	Part	Function
	Power	DC +12V power input
②	RS-422/485	Serial port for PTZ control and etc
③	RS-232	Serial port for PTZ control and etc

System Connections

Video server operates as one mode; Encoder. Video server systems can be connected in either 1-to-1 fashion where one encoder is connected one decoder or 1-to-many fashion where one encoder connected to many decoders.

Following chart shows data status of video, audio and serial data.

System Mode	Video	Audio	Serial Data
Encoder	Transmit	Transmit	Transmit/Receive

The system mode is defined by the video communication and the system mode is capable of single directional transmission of audio and bi-directional of serial data.

Topology

Generally, the encoder and a decoder are connected in 1-to-1 mode. To support specific situation, 1-to-multiple connection is also supported.

● **1:1 Connection (Unidirectional Transmission).**



The most commonly used configuration is 1 to 1 connection. An encoder is installed at a site where video images can be transmitted and a decoder is installed at a center location to receive and view the video images on monitors. Audio and serial data are transferred in either direction.

A decoder and encoder can be connected by setting the encoder's address at the decoder's remote IP

● **1:N Connection (Unidirectional Transmission).**

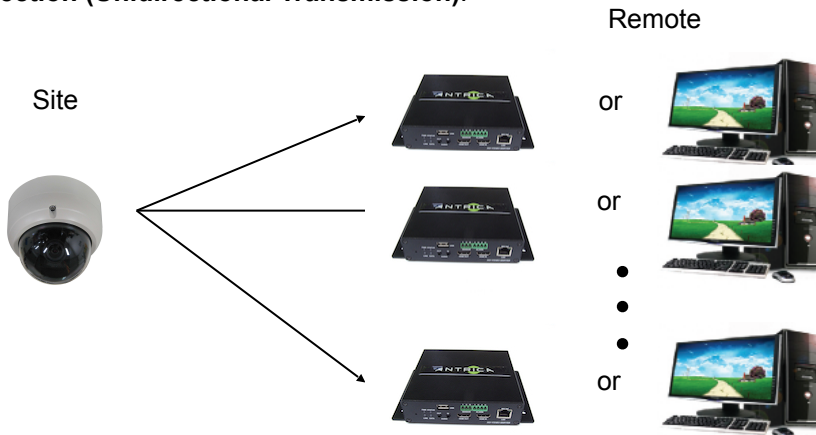

In this configuration, a site can be monitored from many remote center locations. Maximum connections would be limited by the network bandwidth.

Functionally, the VMS (Video Management System) software can replace the decoder.

Multicast Mode

In the network supporting multicast mode, if **Multicast** is setup as a system protocol, you can use bandwidth efficiently regardless of the number of decoders. In 1:N connection, a large number of decoders can receive audio and video data from an encoder by using a single streaming transmission.

● **Relaying**

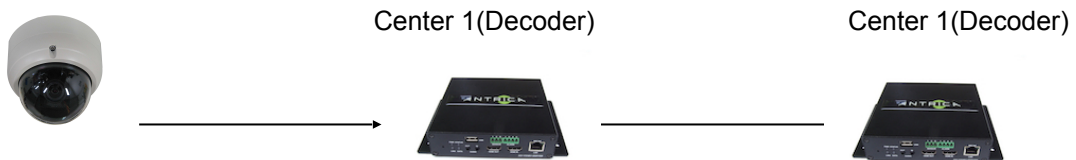

In this arrangement, video and audio can be retransmitted from a center to another center. The arrangement is useful when the network bandwidth at the site is limited while there is more than one center wanting to monitor the site.

● **VMS(Video Management System)**

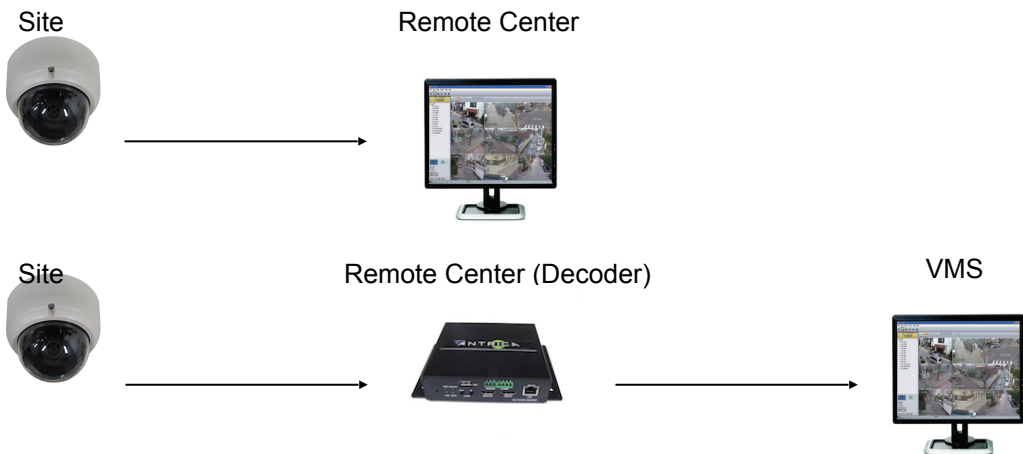

VMS (Video Management System) is a Windows based remote monitoring program to access multiple encoders for real-time monitoring or control of the encoders and connected cameras. Please refer to VMS User Manual for more information on VMS.

2. Installation

Connecting Video

- **PC Encoder System**

Connect PC video output line to the encoder (video server) video input port.

- **Connecting with Megapixel Camera**

Connect a camera which supports HDMI or 3G/HD-SDI output to the HDMI or 3G/HD-SDI Input port of video server accordingly.

- **Connecting with D1 resolution Camera**

Connect a camera to the Video Input port of video server accordingly.

Connecting Audio

It is possible to set the mode as Tx-only or audio off.

- Connect audio input and output ports to audio devices accordingly.
- The Audio signal required is line level, 1volt Pk Pk so audio equipment with an amp, mixer or other amplifier should be used.

Connecting Serial Ports

For camera control, PTZ controller (keyboard) and receiver can be connected to serial ports. Two corresponding serial ports in encoder and decoder which are connected in 1-to-1 fashion works in pass-through mode. This means that commands at a local system's COM1 port will be transparently passed to the remote system's COM1 port. Also, a command at a local system COM2 port will pass to the remote system's COM2 port.

Connecting Sensor and Alarm

Connect sensor and alarm devices to corresponding terminals accordingly.

Connecting Power

After confirming the power source, connect power adaptor and connect the 12VDC connector to the system.

Check if it Works

Once the power is supplied to the camera, it will start booting. The system will boot up to an operating mode after approximately 40-60 seconds. The green LED on the Ethernet port will flash indicating the system is ready.

Software provided in the support site (Cloud) called True Manager allows you to check the IP address and other network details of the server. Please refer to the True Manager manual for instructions on how to find the IP address of the server and if required changing it.

- **Encoder LED Display**

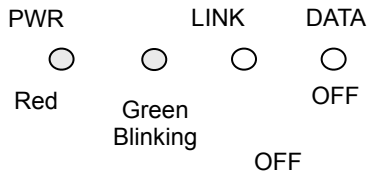

These LEDs show that the camera is connected but a decoder is not connected.

Once the encoder is connected to a decoder, colour of “LINK” LED will turn to a green colour and “ DATA” LED will blink as video or audio transmissions occur

- Description of LED

System status can be monitored with LED display

LED	State	Description
PWR	Off	Power off
	Red	Power on
STATUS	Green blinking	Normally operating
	Red	System failure: Needs diagnostics
LINK	Off	No connection to remote system
	Green	Connected to a remote system
	Red blinking	Decoder only: trying to connect to an Encoder
	Orange	Illegal connection (unsupported combination of system modes)
DATA	Green	Data transmission in progress
	Red	Data loss
	Off	No data transmission

3. System Operation

●Remote Video Monitoring

There are two ways to monitor video when the centre system and server are connected. In order for a proper operation, an IP address must be set accordingly. Please refer to **True Manager Manual** for further details.

- **Default ID** : admin
- **Default Password** :1234

Video Monitoring using Internet Explorer

Open Internet Explorer and enter camera's IP address. The system will ask for confirmation to install Active-X control. Once authorised, Internet Explorer will start to display video images from camera as shown below.

- **Default IP Address** : <http://192.168.10.100>

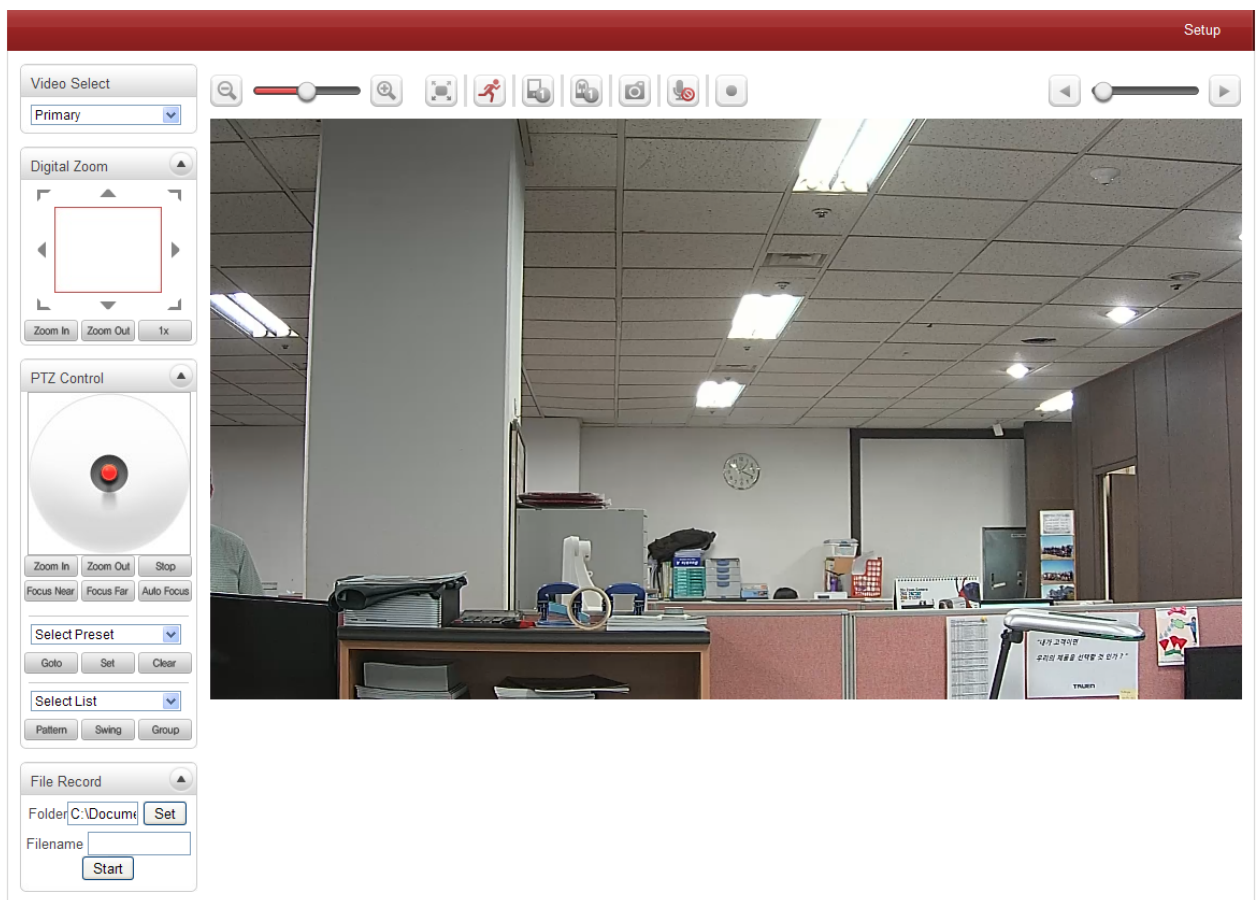

◆ **Video Select**

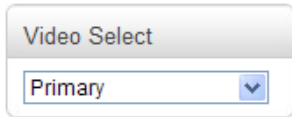

Select the Video stream to be viewed : Primary, Secondary, tertiary or quartic streaming. This camera is capable of Quad streaming; primary streaming and secondary streaming Video will be displayed according to the resolution set on video configuration. If dual streaming (“**Use Dual Encode**” Menu in Video page) is not activated, secondary video is not available

◆ **View Size**



Adjust the size of the screen. Screen size if initially adjusted according to the compression resolution. Click on 50% icon and the whole screen size will be reduced to half size.

◆ **Digital Zoom**

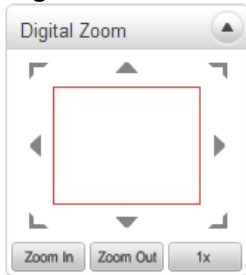

Control the Digital zoom on the screen The more the camera zooms in, the smaller the square of control panel is. Position of the image can be changed by moving position of the square. If you press x1, the screen will return to the normal size.

◆ **PTZ Control (Optical Zoom & Digital Zoom Built-in the Camera)**



Control PTZ and PTZ Control Panel is used for controlling external PTZ devices when the external PTZ devices are connected through serial port. It is possible to make zooming control by **Zoom in/out** buttons of PTZ control Panel (In order to use digital zoom, select **Digital zoom ON** in the Camera tab)

- **Stop**
Stop on-going action
- **Focus Near, Focus Far, Auto Focus**
Adjust the focus of the lens

◆ **Select Preset**

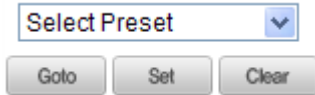

Set preset position and move to the specific preset position.

- **Goto**
Move to the selected preset entry if the preset entry is set.
- **Set**
Set the current position to the selected preset entry.
- **Clear**
Delete the selected preset entry.

◆ **Sensor Input and Alarm Output**



Display the status of the sensor in real time.

This camera supports one sensor input. When the sensor of the camera is working, the sensor light turns red. Operate the alarm device by pressing the number icon. This camera supports one alarm output. A number icon indicates status of the alarm device.

◆ **Snapshot**



Capture video images and store them as BMP or JPEG files.

◆ **Talk**



Transfer audio from PC's mic to the camera.

◆ **File Record**

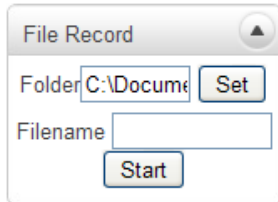

Recording to an AVI file on Live View page is available. AVI files are generated in the specified folder or in a specified file name on the PC where web browser is running.

1. Press "**Set**" button to select a folder or create a new folder. Enter the file name on a filename field.
2. Press "**Start**" button to start recording.
3. Press "**Stop**" button to stop recording.
4. An AVI file named "**IP address_hh_mm_ss**" or "**File name_IP address_hh_mm_ss**" will be generated in the specified folder depending on where the path specified folder or a prefix of the file name.

◆ **Display Buffer**



Set the number of video frames to be buffered before being displayed on web browser. Larger value results in smoother video by sacrificing the latency. A setting of 10 ~ 15 frames can be used generally for most situations.

Video Monitoring with Decoder System

Once camera's IP address is set in the remote IP address section of the decoder, the decoder system will connect to camera and start receiving the video images. Normally, a monitor connected to the decoder will display video images

re-initialisation of IP Address

If a system IP address is lost, the system can be reset to the system default IP address using the reset button in the back side of the system.

1. While the system is in operation, press the reset button for more than 5 seconds.
2. The system will reboot automatically.
3. Once the system reboots, IP address will be set to the system default as below;

• IP mode	Fixed IP	• IP address	192.168.10.100
• Subnet mask	255.255.255.0	• Gateway	192.168.10.1
• Base port	2222	• HTTP port	80

4. Remote Configuration

●Using the Web Browser

Remote setting is available by using web browser. Enter IP address of camera and then a live view screen appears as below. Press **Setup** button located in the upper right area of the monitoring screen to go to the server setup. For Remote Setting, user should be authorised higher than manager level.

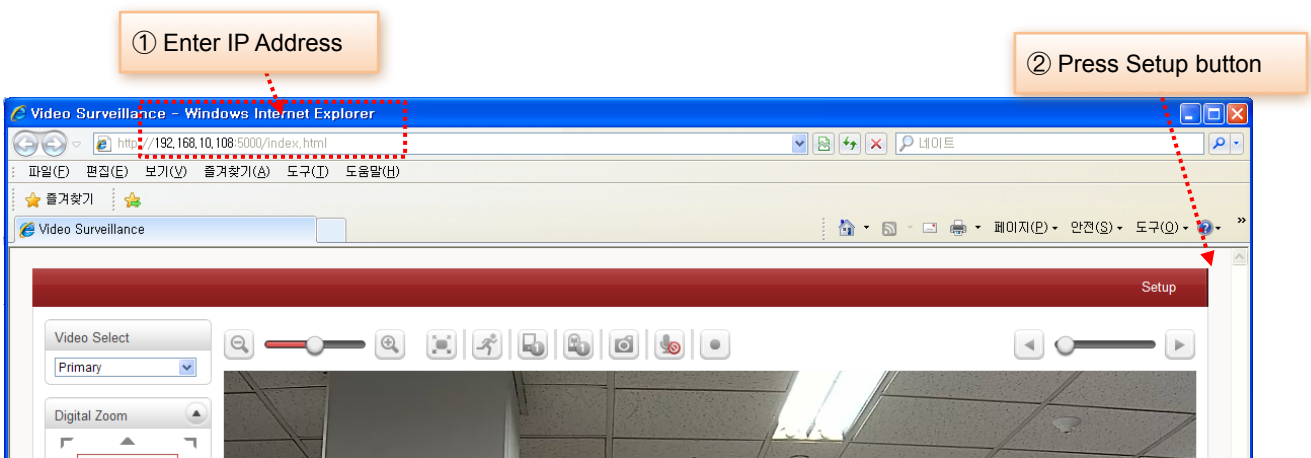

The configurations are grouped into 9 categories: **Video & Audio, Image, Network, Event, Record, Device, PTZ, System, User**. Leaving the page without pressing **Apply** button, any changes in the page will be discarded.

●Video & Audio Information

live

Video&Audio -

- Information
- Encode
- Audio
- Output
- Image +
- Network +
- Event +
- Record +
- Device +
- PTZ +
- System +
- User +

Video

	Enable	Algorithm	Resolution	Bitrate	Framerate
Primary encoding	On	H.264	1920x1080	5790 (kbps)	60 (fps)
Secondary#1 encoding	Off	N/A	N/A	0 (kbps)	0 (fps)
Secondary#2 encoding	Off	N/A	N/A	0 (kbps)	0 (fps)
Secondary#3 encoding	Off	N/A	N/A	0 (kbps)	0 (fps)

Time (min)	Primary (kbps)	Secondary#1 (kbps)	Secondary#2 (kbps)	Secondary#3 (kbps)
35	7000	0	0	0
40	6800	0	0	0
45	8000	0	0	0
50	6800	0	0	0
55	7000	0	0	0
60	6800	0	0	0
65	7000	0	0	0
70	6800	0	0	0
75	7000	0	0	0
80	6800	0	0	0
85	7000	0	0	0
90	6000	0	0	0

Audio

	Enable	Algorithm	Samplerate	Bitrate
Audio encoding	On	G.711	8 KHz	66 (kbps)
Audio decoding	On	-	-	0 (kbps)

The information provides current information regarding the settings for video and Audio

Encode

Live

Video&Audio -

- Information
- **Encode**
- Audio
- Output
- Image +
- Network +
- Event +
- Record +
- Device +
- PTZ +
- User +
- System +

View



Performance Calculation

Performance Usage Rate **100%**

Encode

Input Format: HDMI 1080p60

Video Input Auto Detect: Full Auto Mode

HDMI 1080P (1920,1080)

Primary
Secondary#1
Secondary#2
Secondary#3

Resolution: 1920x1080

Framerate: 60

Preference: CBR

Quality: Economy

Bitrate: 4000 kbps (32 ~ 16384)

I-Frame Interval:

30

H.264 Profile: High Profile

Apply

- **Performance Calculation**
Shows the performance usage rate according to the value set at 'Encode' mode underneath.
- **Input Format**
Choose the input format from the list of HDMI resolutions and frame rates
- **Video Input Auto Detect**
Choose the Auto Detect mode. If it is Full Auto Mode, it will be displayed automatically.
If it is Semi Auto Mode, user should select Input format.

- **Resolution**
Select video encoding solution.
Scaling option is used when encoding resolution is different from input resolution. Without Scaling option, input video will be cut according to encoding resolution. On the other hand, if Scaling is selected, input video will be adjusted according to encoding resolution.
- **Framerate**
Determine the maximum number of frames per second for the video stream.
1,2,3,4,5,6,8,10,15,20,25,30 and 60 frame rate can be selected. The actual frame rate of video can be less than the maximum frame rate set due to the network bandwidth limitation
- **Preference**
Select encoding mode to control video quality or bitrate: Quality(VBR) or Bit rate(CBR). If 'Bitrate' selected, the video encoding will be effected by the 'Bitrate' value entered. Therefore, "Bitrate" mode corresponds to CBR (Constant Bit rate) encoding. If 'Quality' selected, the video encoding will be effected by the quality of image selected. Therefore, "Quality" mode corresponds to VBR (Variable Bit Rate) encoding.
- **Quality**
Select Video quality. 7 levels of quality are available.
Quality mode (VBR encoding) tries to encode every frame in a constant quality. Therefore, resulting bitrate may vary a lot depending on the complexity or activity changes in the input video. It is preferred when constant video quality is required and network bandwidth is enough for delivering the stream of highly varying bitrate.
- **Bitrate**
Determine bitrate value between 32 ~ 16Mbps.
Bitrate mode (CBR encoding) allows you to set a fixed target bitrate that consumes a predictable amount of bandwidth. In order to keep the bitrate limit, video quality is controlled dynamically according to the complexity or activity changes in the input video.
- **I-Frame Interval**
Determine I-frame Interval between 1 and 255.

- **H.264 Profile**

Select H.264 Profile : **High Profile** or **Baseline Profile**

The standard defines various sets of capabilities which are referred to as profiles, targeting specific classes of application.

I. **High Profile**

The Primary profile for broadcast and disc storage applications, particularly for high-definition television application.

II. **Baseline Profile**

Primarily for low-cost applications that require additional data loss robustness, this profile is used in some videoconferencing and mobile application. This profile includes all features that are supported in the constrained baseline profile, plus three additional features that can be used for loss robustness.

- **Secondary #1 ~ #3**

The screenshot shows the 'Encode' configuration window with tabs for Primary, Secondary#1, Secondary#2, and Secondary#3. The Secondary#1 tab is active. The configuration includes:

- Enable:** Radio buttons for Off and On (On is selected).
- Algorithm:** Radio buttons for H.264 and MJPEG (MJPEG is selected).
- Resolution:** A dropdown menu showing '1920x1080' and a checked 'Scaling' checkbox.
- Framerate:** A dropdown menu showing '30'.
- Preference:** A dropdown menu showing 'VBR'.
- Quality:** A dropdown menu showing 'Very fine'.
- Bitrate:** A text input field showing '1024' kbps, with a range of '(32 ~ 4096)' indicated.

- **Use Dual Encode**

Select **ON** to enable to use Secondary #1 ~ #3.

The Secondary #1 ~ #3 video can be viewed on **Live View** window by selecting **Stream number** on Video selection

- **Algorithm**

Select H.264 or MJPEG for the secondary, tertiary or quartic streaming.

In case of H.264, wither bitrate mode or Quality mode can be selected for Preference mode in. On the other hand, MJPEG supports **Quality** mode

Audio

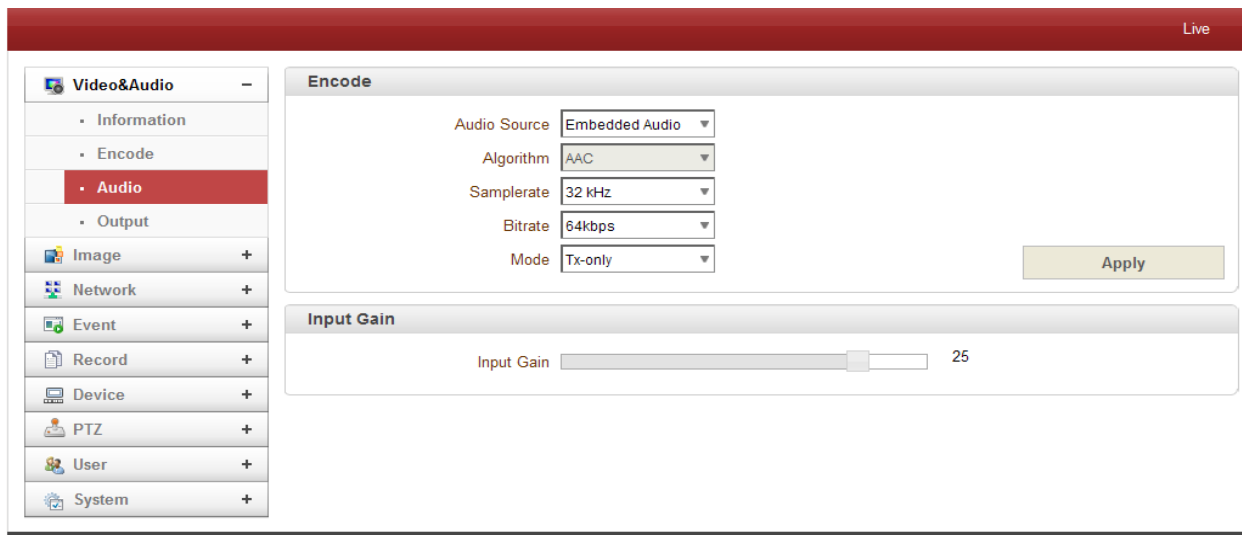

- **Audio Source**

Select the audio source: Embedded or Analog stereo

- **Algorithm**

Select the audio algorithm: G.711 or AAC

G.711 and AAC from client to server direction are supported. Thus, bidirectional audio communication is supported.

- **Samplerate**

The sampling rate defines the number of samples per unit of time taken from a continuous signal to make a discrete signal.

- **Bit rate**

Select the bitrate between 64Kbps and 128kbps when AAC is selected

The sampling rate is fixed to 8KHz and 32KHz for G.711 and AAC respectively.

Note that when camera is connected to a decoder, the decoder's audio algorithm should be set identically to transmit audio properly.

- **Mode**

Select audio operation mode

Mode	Action
Off	No operation
Tx-Only	Transmit only
Rx-Only	Receive only
Tx & Rx	Transmit and Receive

- **Input Gain**

Set audio input gain from 0 to 31.

Output

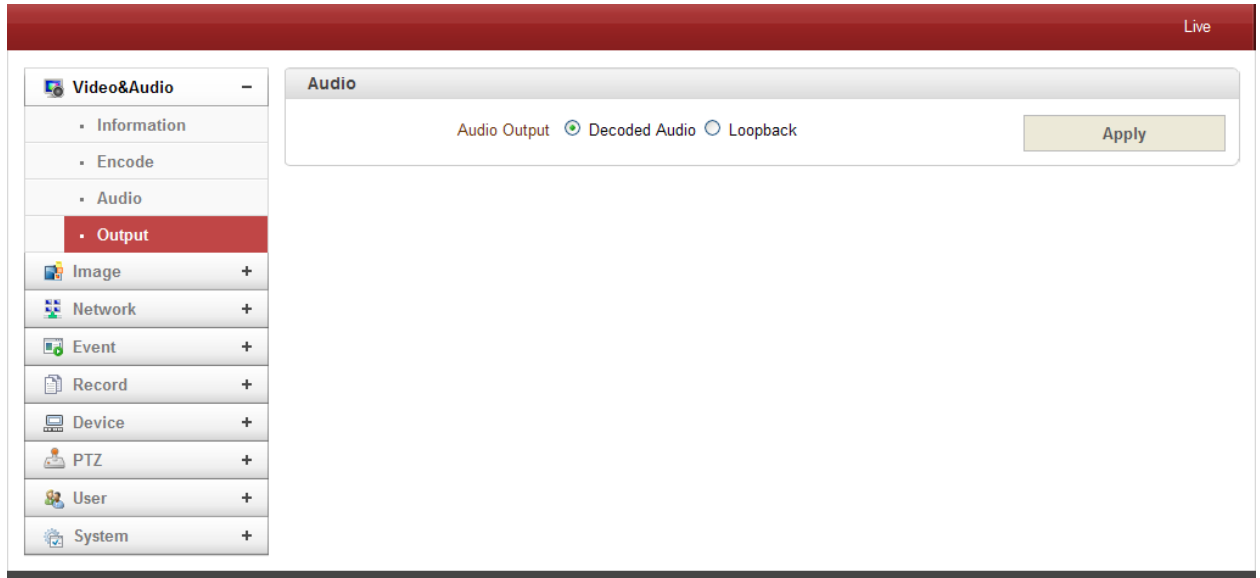

- **Output Format**

Select the format of output when Enable Preview is selected.

●Image

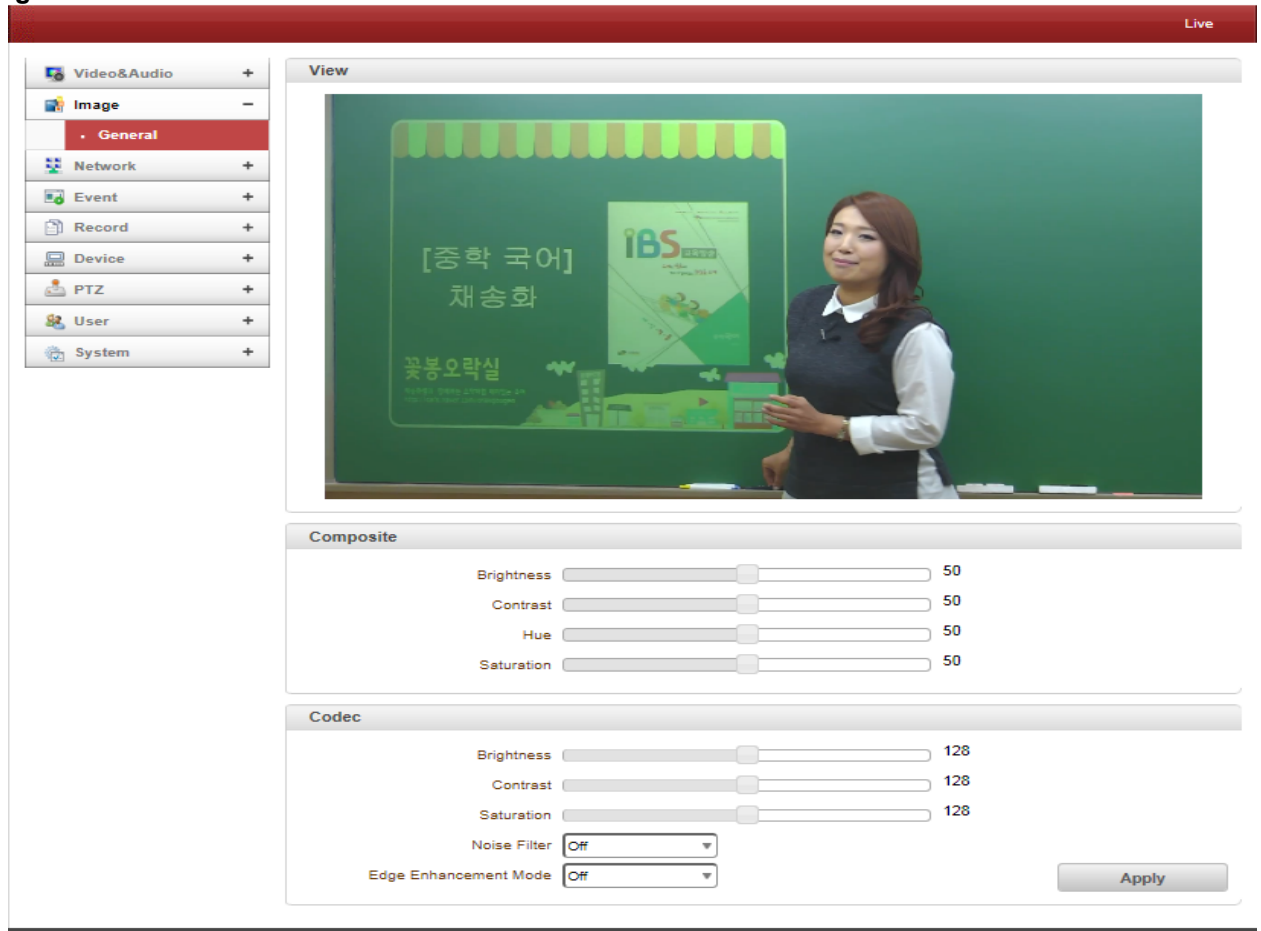

Composite

It works when it connects only composite input source

| Brightness

Controls input video brightness by selecting values between 0 and 255.

| Contrast

Controls input video contrast by selecting values between 0 and 255.

| Hue

Controls input video Hue by selecting values between 0 and 255

| Saturation

Controls input video saturation by selecting values between 0 and 255

Codec

| Brightness

Controls input video brightness by selecting values between 0 and 255.

| Contrast

Controls input video contrast by selecting values between 0 and 255.

| Hue

Controls input video Hue by selecting values between 0 and 255

| Saturation

Controls input video saturation by selecting values between 0 and 255

Noise Filter

Noise Filter (NR) is used in order to obtain a high quality output image and enhance compression efficiency. This camera offers Edge Preserving 2D NR and Motion Adaptive 3DNR.

2DNR Mode: 2D-NR offers the 2D-edge preserving & flat area noise reduction which preserves the edge zone by identifying the 5x5 Bayer pattern data's edge zone and eliminates the noise on the flat zone.

3DNR Mode: This camera performs 3D noise reduction by estimating the noise level of current and previous input video. It effectively suppresses artifacts such as ghost-tail, etc., by using the motion adaptive method which reduces noise to a lesser extent in motion area where inter-pixel difference between current and previous video is greater than noise level measured and reduces noise to a greater extent in area where the inter-pixel difference is relatively small compared to the noise level measured.

Edge Enhancement

Edge Enhancement is an image processing filter that enhances the edge contrast of an image or video in an attempt to improve its acutance(apparent sharpness)

● **Network**

IP & Port

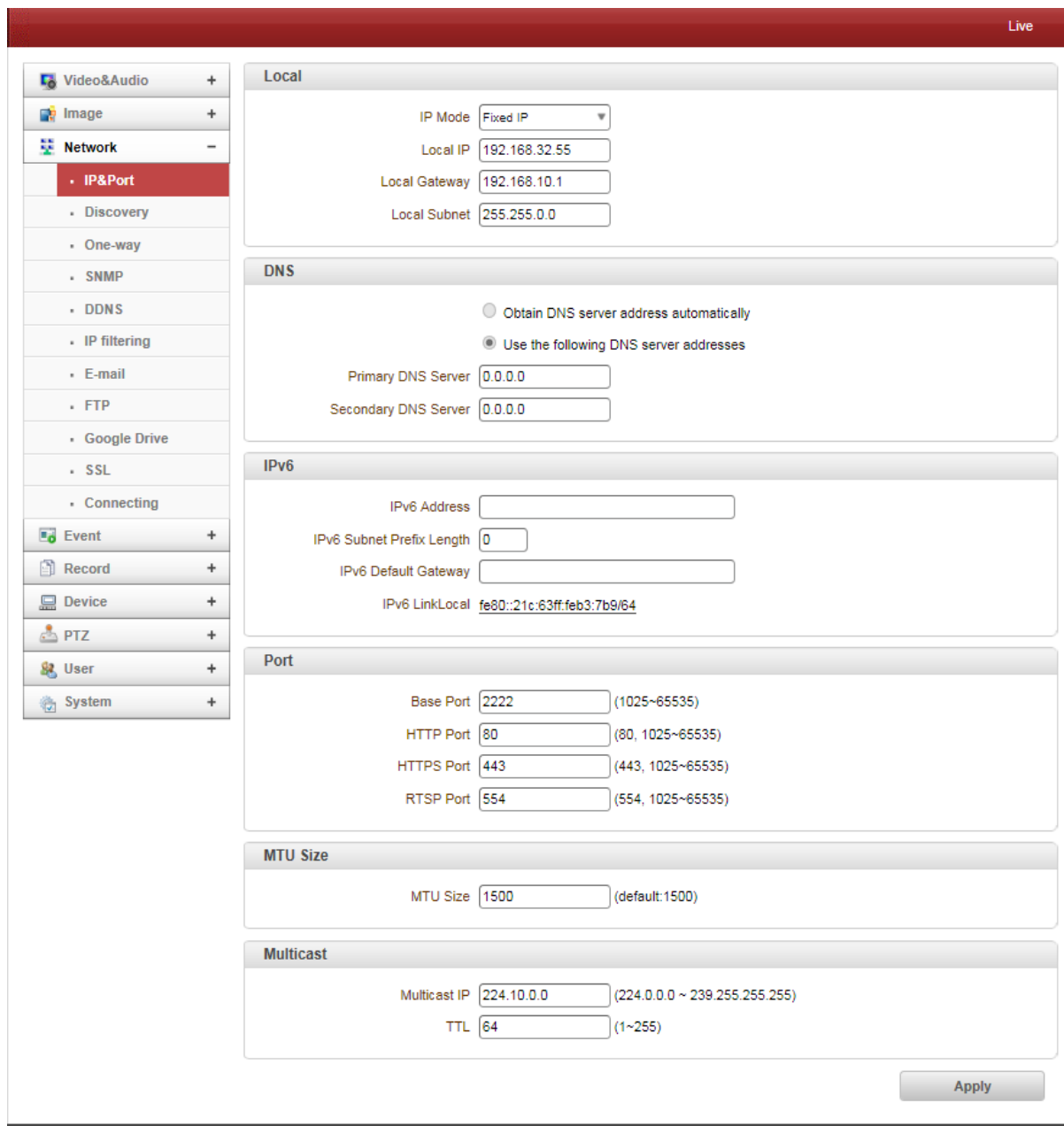

- **Local**

Select the IP mode: Fixed IP or DHCP

Depending on the selected mode, further configuration items comes as follows,

IP Mode	Selection	Description
Fixed IP	Local IP	Fixed IP address
	LocalGateway	Gateway IP address
	Local Subnet	Subnet mask
DHCP	N/A	

Please ask IP address information from ISP provider or network manager.

- **DNS**

- **Obtain DNS server address automatically**

Get DNS server address automatically when IP mode is DHCP.

➤ **Use the following DNS server address**

Enter the DNS server IP address; Primary or Secondary DNS server

Domain Name System (DNS) is a database system that translates a computer's fully qualified domain name into an IP address. Networked computers use IP addresses to locate and connect to each other, but IP addresses can be difficult for people to remember. For example, on the web, it's much easier to remember the domain name www.amazon.com than it is to remember its corresponding IP address (207.171.166.48). Each organization that maintains a computer network will have at least one server handling DNS queries. That server, called a name server, will hold a list of all the IP addresses within its network, plus a cache of IP addresses for recently accessed computers outside the network.

- **IPv6**

- **Ipv6 Address:** Enter the designated Ipv6 address.
- **Ipv6 Subnet Prefix Length:** Enter the bit number of Ipv6 Subnet
- **Ipv6 Default Gateway:** Enter the designated Ipv6 gateway.
- **Ipv6 Link Local:** Display Ipv6 Link Local.

- **Port**

➤ **Base Port (1025~65535)**

Enter the Base Port number

Network base port is used for communication with remote clients. In order for camera and remote systems to be connected, the port number must be identically configured in camera side and client side.

➤ **HTTP Port (80, 1025~65535)**

Enter HTTP port used for web-based connection.

➤ **HTTPS Port (443, 1025~65535)**

Enter HTTPS port used secured HTTP connection.

➤ **RTSP Port (554, 1025~65535)**

Enter RTSP port used for RTSP-based connection. The default TRSP port is 554.

RTSP (Real Time Streaming Protocol) is a standard for media streaming between server and client.

- **Multicast**

The Multicast menu is used for configuring the multicast IP address to which media stream is delivered when a client such as a Decoder, VMS or NVR software is connected in multicast mode. The multicast IP address selection range is between 224.0.0.0 and 239.255.255.255. The selection can be used only when media protocol is set to Multicast.

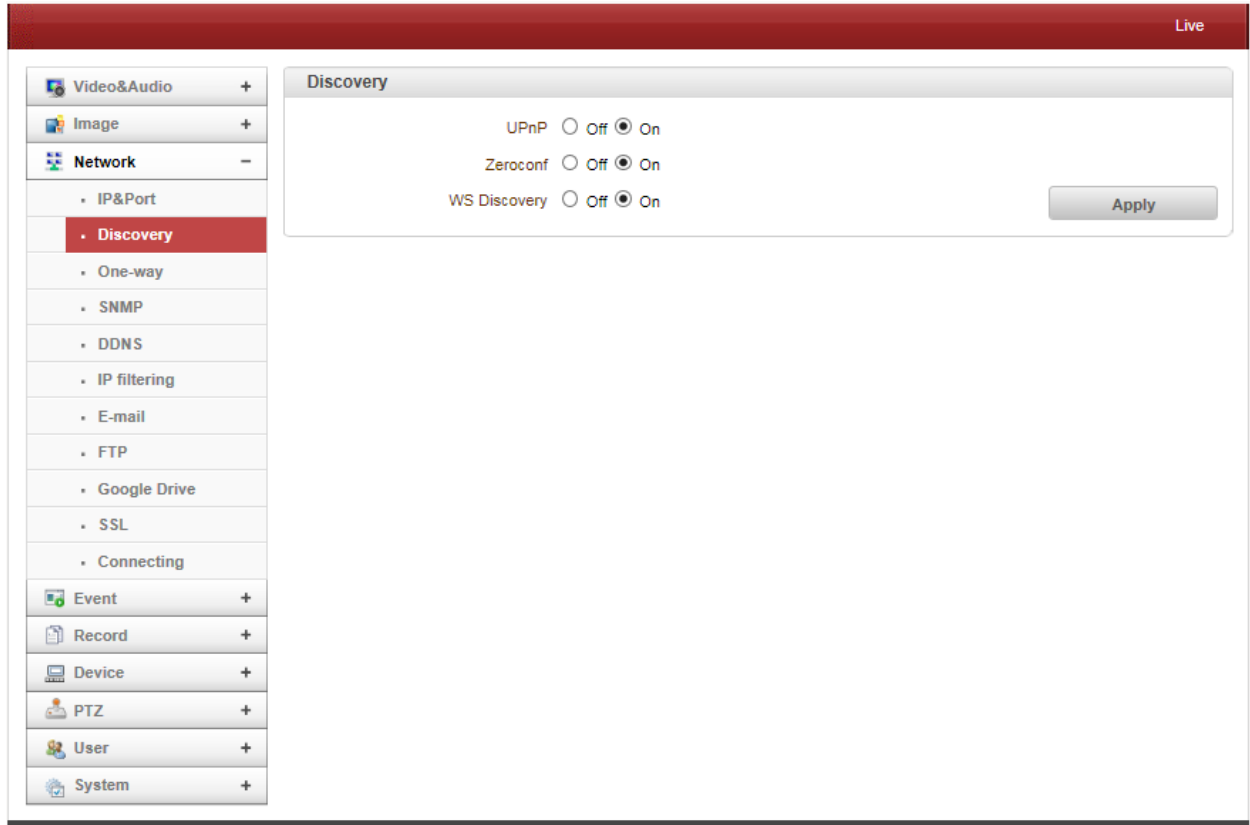
Discovery

- **UPNP**
By the setting **UPNP** to ON, it allows the discovery by the clients according to UPNP (Universal Plug and Play) protocol.
- **Zeroconf**
By setting **Zerodonf** to ON, it allows the discovery by the clients according to zeroconf protocol.
- **WS Discovery**
Discovery function based on web service is enabled. It allows the discovery by the client SW which is supporting Onvif.

One-way

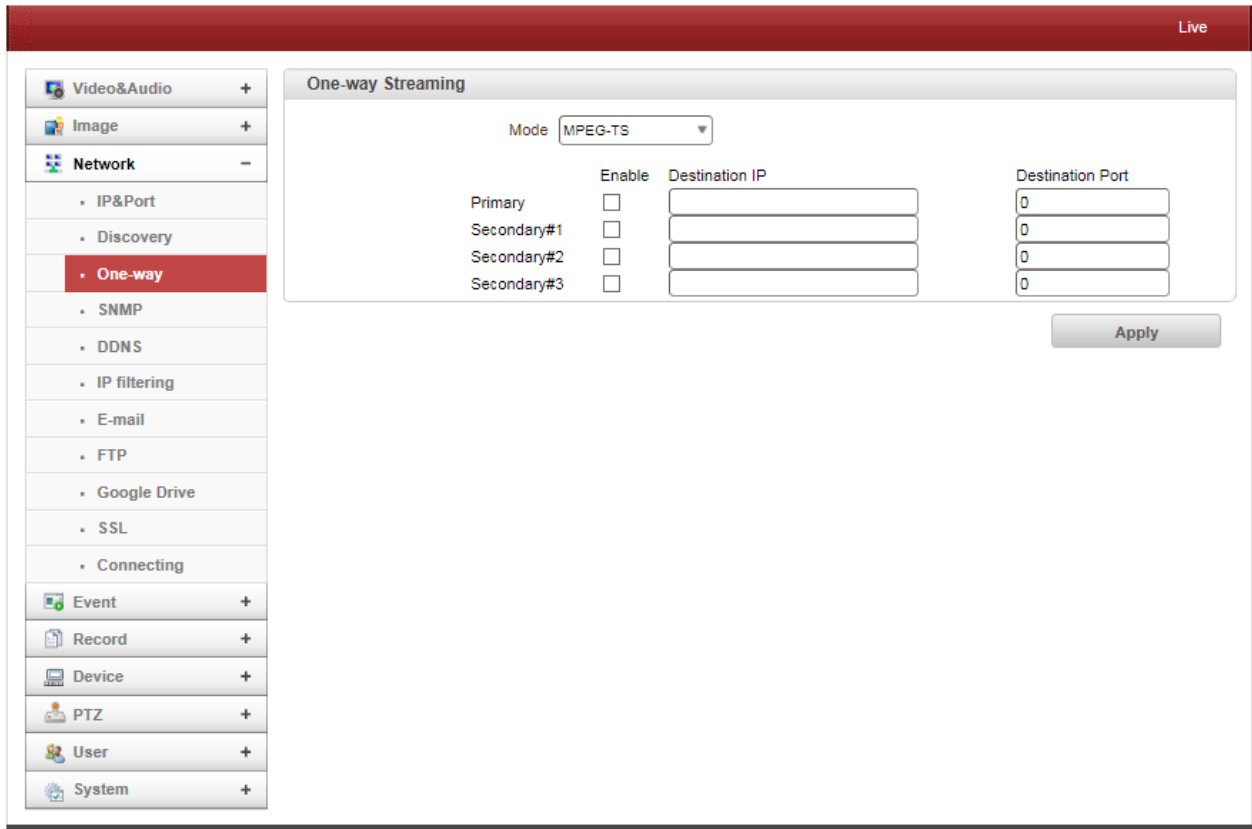

- This IP camera provides two kinds of one-way (unidirectional) streaming based on UTP to clients; **RTSP** and **MPEG-TS**. Both are a kind of broadcasting where traffic from clients to a server is not generated at all.
- **RTP (Real-Time Transport Protocol)** is an Internet protocol used for transmitting single real-time multimedia data such as audio and video to a select group of connected clients. Normally RTSP uses RTP to format packets of multimedia content. **RTSP** menu is used when the RTP only streaming without RTSP connection. RTP stream will be transmitted to the destination set. The SDP (Session Description Protocol) file can be found in the server, and a client can retrieve it using http connection.

- **Related settings are as follows:**

- **Destination IP :** Set the IP Address of the destination system which will receive RTP Stream. If the system is a decoder, RTSP authentication information can be in the middle of RTSP URL as follows;

rtsp://[admin:1234](#)@192.168.10.100:554/video1
- **Destination Port :** Set the port of the destination system which will receive TRP stream.
- **User Name :** Enter the user name that will be used as session name in the SDP file.
- **File Name :** Enter the file name that will be used as the name of the SDP file. Then, it can be accessed through [http://ServerAddress/filename](#)

- **MPEG-TS** is a standard format for transmission and storage of audio, video, and data,[7] and is used

in broadcast systems such as DVB and ATSC. Transport Stream is specified in MPEG-2 Part 1, Systems (formally known as ISO/IEC standard 13818-1 or ITU-T Rec. H.222.0). Transport stream specifies a container format encapsulating packetized elementary streams, with error correction and stream synchronization features for maintaining transmission integrity when the signal is degraded. As MPEG-TS itself supports only AAC as the audio algorithm, only video is streamed when audio algorithm is set to G.711.

- **Related settings are as follows:**

- > **Destination IP** : Set the IP Address of the destination system which will receive MPEG-TS stream.
- > **Destination Port** : Set the Port of the Destination system which will receive MPEG-TS stream.

SNMP

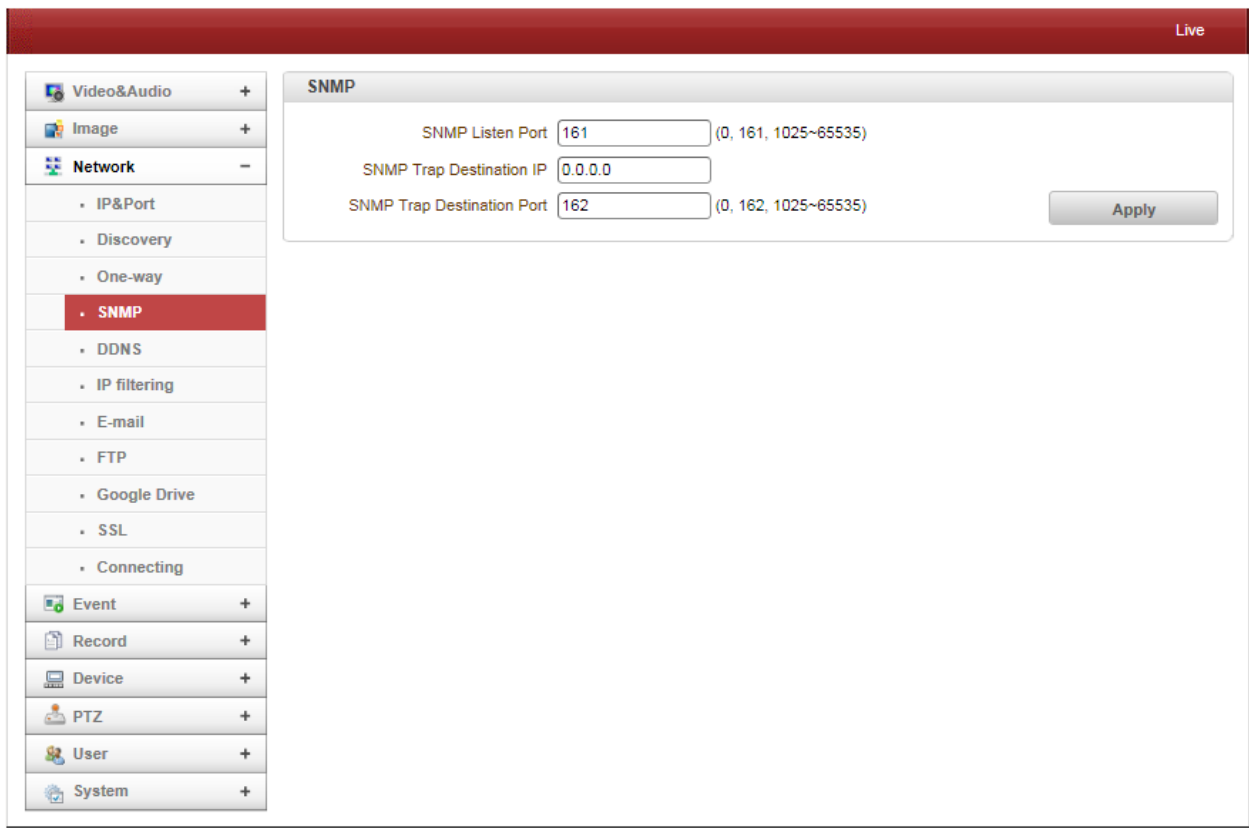

Setup for using SNMP (Simple Network Management Protocol). It is compatible to both SNMPv1 and SNMPvec. Settings for using SNMP are as following;

- **SNMP Listen Port (0, 161, 1025 ~ 65535)**

The port is for connecting external device when system operates as a SNMP client. SNMP is not used by setting 0 value.

- **SNMP Trap Destination IP**
Set the SNMP Trap Destination IP.
- **SNMP Trap Destination Port (0, 162, 1025 ~ 65535)**
Set the SNMP Trap Destination Port. SNMP is not used by setting 0 value.

Simple Network Management Protocol (SNMP) is used by network management systems to communicate with network elements. SNMP lets TCP/IP-based network management clients use a TCP/IP-based internetwork to exchange information about the configuration and status of nodes. SNMP can also generate trap messages used to report significant TCP/IP events asynchronously to interested clients. For example, a router could send a message if one of its redundant power supplies fails or a printer could send an SNMP trap when it is out of paper

DDNS

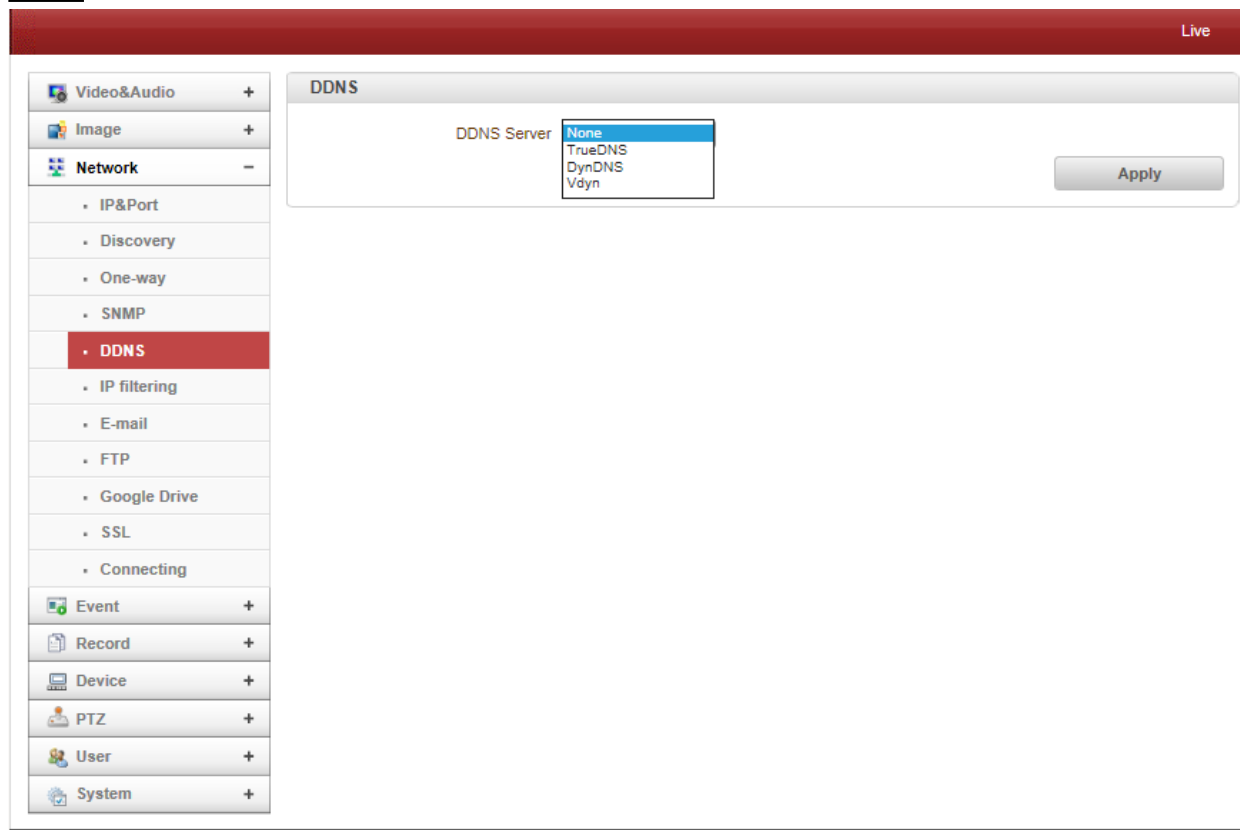

Select DDNS (Dynamic DNS) server to use. One of the two can be selected.

- **TrueDNS**
True DNS service is used in the mode. Systems can be registered on the website for True DNS service, <http://ns1.truecam.net>. A system will get a domain name of xxx.truecam.net. Please refer to user guide document for True DNS service.

- **DynDNS**

Dyn DNS service is used in this mode. Refer to www.dyndns.org for details. ID, Password and Domain name are needed when DYN DNS is set.

Dynamic DNS is a method, protocol, or network service that provides the capability for a networked device, such as a router or computer system using the Internet Protocol Suite, to notify a domain name server to change, in real time (ad-hoc) the active DNS configuration of its configured hostnames, addresses or other information stored in DNS.

- **Vdyn**

Vdyn is a DDNS service provided by Visionica (<http://visionica.com>). No further configuration is required for using this service. It internally uses MAC address for the registration. When it succeeds, the domain name of the form 001C63A607EC.visionica.info is displayed on Current Domain entry of Network page. E-mail setting is not mandatory.

- **Check IP Disable**

If "Check IP Disable" is selected, it will skip to check its own IP. In fixed IP mode, the set IP will be registered on DDNS server. In DHCP mode, dynamically assigned IP will be registered on DDNS server. Normally **Check IP Disable** should be unchecked in order to obtain public IP in the network.

IP filtering

Live

- Video&Audio +
- Image +
- Network -
- IP&Port
- Discovery
- One-way
- SNMP
- DDNS
- IP filtering
- E-mail
- FTP
- Google Drive
- SSL
- Connecting
- Event +
- Record +
- Device +
- PTZ +
- User +
- System +

IP Filtering

Basic Policy Allow all

Access from IPs in the following list will not be allowed.

No.	From	To	Enable
1	<input type="text" value="0.0.0.0"/>	<input type="text" value="0.0.0.0"/>	<input type="checkbox"/>
2	<input type="text" value="0.0.0.0"/>	<input type="text" value="0.0.0.0"/>	<input type="checkbox"/>
3	<input type="text" value="0.0.0.0"/>	<input type="text" value="0.0.0.0"/>	<input type="checkbox"/>
4	<input type="text" value="0.0.0.0"/>	<input type="text" value="0.0.0.0"/>	<input type="checkbox"/>
5	<input type="text" value="0.0.0.0"/>	<input type="text" value="0.0.0.0"/>	<input type="checkbox"/>
6	<input type="text" value="0.0.0.0"/>	<input type="text" value="0.0.0.0"/>	<input type="checkbox"/>
7	<input type="text" value="0.0.0.0"/>	<input type="text" value="0.0.0.0"/>	<input type="checkbox"/>
8	<input type="text" value="0.0.0.0"/>	<input type="text" value="0.0.0.0"/>	<input type="checkbox"/>
9	<input type="text" value="0.0.0.0"/>	<input type="text" value="0.0.0.0"/>	<input type="checkbox"/>
10	<input type="text" value="0.0.0.0"/>	<input type="text" value="0.0.0.0"/>	<input type="checkbox"/>
11	<input type="text" value="0.0.0.0"/>	<input type="text" value="0.0.0.0"/>	<input type="checkbox"/>
12	<input type="text" value="0.0.0.0"/>	<input type="text" value="0.0.0.0"/>	<input type="checkbox"/>
13	<input type="text" value="0.0.0.0"/>	<input type="text" value="0.0.0.0"/>	<input type="checkbox"/>
14	<input type="text" value="0.0.0.0"/>	<input type="text" value="0.0.0.0"/>	<input type="checkbox"/>
15	<input type="text" value="0.0.0.0"/>	<input type="text" value="0.0.0.0"/>	<input type="checkbox"/>
16	<input type="text" value="0.0.0.0"/>	<input type="text" value="0.0.0.0"/>	<input type="checkbox"/>
17	<input type="text" value="0.0.0.0"/>	<input type="text" value="0.0.0.0"/>	<input type="checkbox"/>
18	<input type="text" value="0.0.0.0"/>	<input type="text" value="0.0.0.0"/>	<input type="checkbox"/>
19	<input type="text" value="0.0.0.0"/>	<input type="text" value="0.0.0.0"/>	<input type="checkbox"/>
20	<input type="text" value="0.0.0.0"/>	<input type="text" value="0.0.0.0"/>	<input type="checkbox"/>

Apply

IP filtering is simply a mechanism that decides which types of IP datagrams will be processed normally and which will be discarded.

Page 34 of 69

34/69-

E-mail

The screenshot shows the 'E-mail' configuration page. On the left is a sidebar with a tree view: Video&Audio (+), Image (+), Network (-), IP&Port, Discovery, One-way, SNMP, DDNS, IP filtering, **E-mail** (selected), FTP, Google Drive, SSL, Connecting, Event (+), Record (+), Device (+), PTZ (+), User (+), System (+). The main content area has a red header bar with 'Live' on the right. Below it is the 'E-mail' configuration panel with the following fields: Server Address (text input), Port (25) with a note '(25, 465, 587, 1025~65535)', Sender Address (text input), Authentication on SMTP Server (radio buttons: Off selected, On), ID (text input), Password (text input), SSL (radio buttons: Disable selected, Enable), and Destination Address (text input). An 'E-mail Test' button is at the bottom right of this panel. Below is the 'E-mail Notification' panel with: Video Clip Attaching (dropdown: Disable), Number of Frame (1) with a note '(1 ~ 6)', and Capture Interval (dropdown: Skip 1 frame). An 'Apply' button is at the bottom right of this panel.

E-mail

Specify the information to send event information, when E-mail is selected as an event action.

- **Server Address**
Enter an address of mail (SMTP) server
- **Port**
Specify a port for SMTP operation (**Port 25 is the default port in SMTP operation.** If a different port is configured in the SMTP server, this ports needs to be changed accordingly.)
- **Sender Address**
Enter an account registered in SMTP server.
- **Authentication on SMTP server**
This function is applicable when the E-mail server requires authentication for sending E-mail.
- **ID & Password**
When the server requires authentication, ID and Password of an E-mail account need to be entered.
- **Destination Address**
Enter Destination address. More than one address can be entered by delimiting comma (,) or semi-colon (;). Destination address can take up to 63 characters.

➤ **E-mail Test**

E-mail sending can be tested with this button. Please note that configured settings should be saved first by pressing **Apply** button before using E-mail Test function. One of the following messages will come as a result of the test.

Message↵	Description↵
E-mail sent successfully↵	Test E-mail has been sent successfully. Reception in the client can be checked.↵
Failed to connect SMTP server↵	Connection to the SMTP server failed. It is necessary to check if the server is reachable and server address and port are correct.↵
Authentication failed↵	The server is reachable but authentication failed. ID and/or password need to be checked.↵
SMTP server rejected the mail↵	The server is reachable, but mail sending failed due to a reason other than authentication. This error happens often when the server authenticates according to its own rule. For example, IP addresses of a specific range or addressed of a specific suffix are allowed.↵

- **E-mail Notification**

➤ Video Clip Attaching

Video clip stored at the moment of event can be attached as an AVI or JPEG file format. When dual encoding is enabled, **Primary video**, **Secondary video** (H.264 only) or **JPEG Capture** can be selected.

The number of JPEG frames is configured. This setting is applicable only when **JPEG Capture** is selected.

➤ **Capture Interval**

Select the interval of captured frame.

FTP

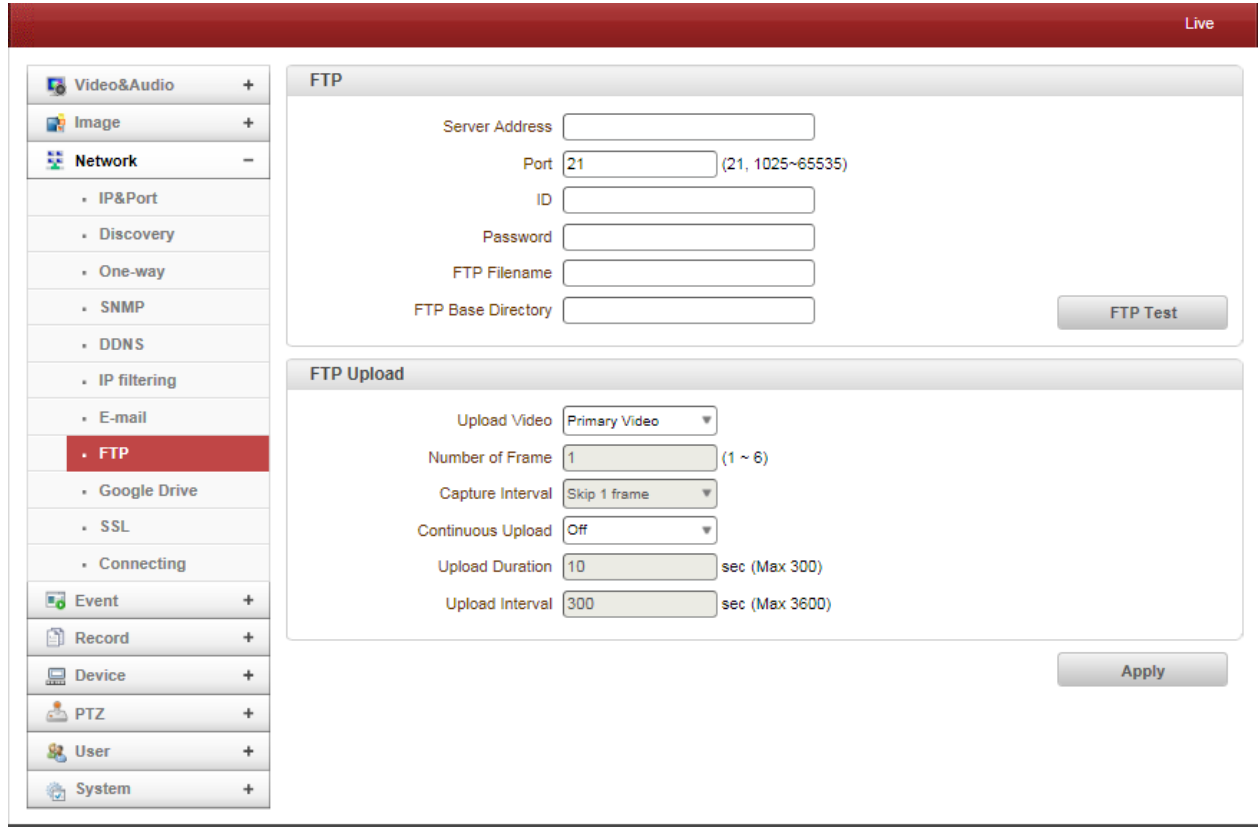

Specify the information to upload event information, when FTP is selected as an event action.

- **FTP**

- > **Server Address**
Enter an address of an RTP server to receive video files
- > **Port**
Specify a port for FTP operation (port 21 is the default port in FTP operation. If a different port is configured in the FTP server, this port needs to be changed accordingly.)
- > **ID & Password**
Enter ID and password for accessing the FTP server.
- > **FTP file name**
The names of files upload by FTP can be specified by user. If a fixed name is specified, the file is overwritten repeatedly.
Max length of a file name is 60 characters. If the name is left blank, file name is determined according to the internal rule implemented in the firmware.
The following macros are supported to form variable parts of file names. The strings are case-sensitive.
 - %YYYY : year
 - %MM : month
 - %DD : day
 - %hh : hour
 - %mm : minute
 - %ss : second

%EVENT : event type (Sensor1, Motion, ...)

%ADDR : address of the server (Domain name when DDNS is used. Otherwise IP address)

“.avi” or “.jpg” will be added automatically at the end of the filename depending on the type of video file.

➤ FTP Base Directory

Specify the name of the directory to be created in the FTP server. It is valid only when Use Record is set to Use on Record session.

➤ FTP Test

FTP upload function can be tested with this button. Please note that configuration settings should be saved first by pressing **Apply** button before using FTP test function. One of the following messages will appear as a result of the test.

Message↕	Description↕
FTP connection tested successfully↕	The connection to the FTP server is successful.↕
Failed to connect FTP server↕	The connection to the FTP server failed. It is necessary to check if the server is reachable and server address and port are correct.↕
Authentication failed↕	The server is reachable but authentication failed. ID and/or password need to be checked.↕
Failed to upload file↕	File upload failed. The user of the ID is not allowed for writing into the directory or FTP server can be full.↕
Failed to erase file↕	Failed to delete the test file. The user of the ID doesn't have the privilege for file deletion.↕

- **FTP Upload**

➤ Upload Video

Primary video and secondary, tertiary or quartic video (H.264 only), JPEG capture can be selected for uploading.

➤ Number of Frame

Enter frame number of JPEG capture. (1 ~ 10)

➤ Capture Interval

Select the interval of captured frame.

➤ Continuous Upload

Continuous upload 'ON' allows video clips to be transmitted regularly regardless of occurrence of event. When this mode is activated, FTP upload by event is suppressed.

- > Upload Duration
Specify recording duration of a video clip to be transmitted. (max 300 sec.)
- > Upload Interval
Specify transmission interval. (max 3600 sec.)
Upload duration is not included in upload interval. For example, if upload interval is 60 sec. and upload duration is 20 sec, a video clip for 20 sec is transmitted every 80 sec.

Google Drive

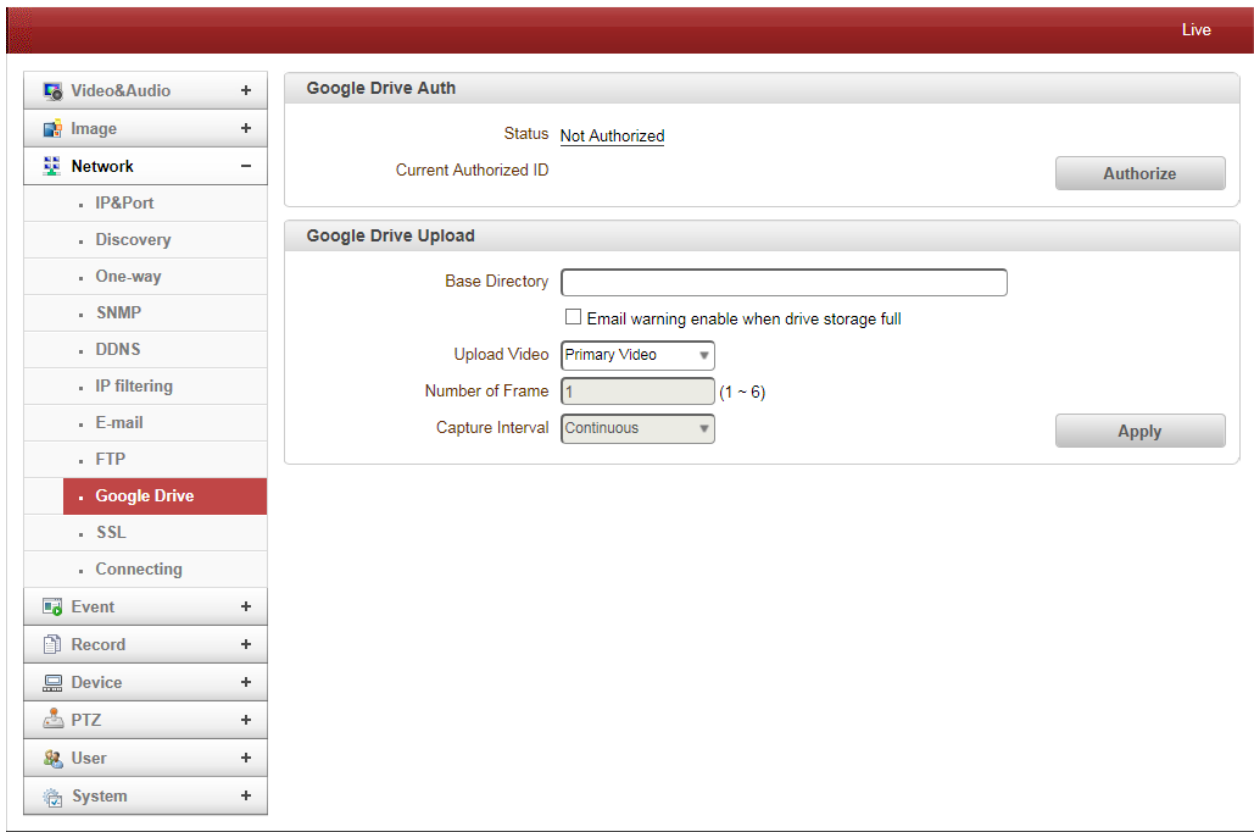

- > Google Drive Auth
First of all, please make Google ID and password, Try to google Drive ID and password for uploading recorded data.
- > Base Directory
Specify the name of the directory to be created in the google drive. It is valid only when Use Record is set to Use on Record session.
- > Upload Video
Primary video and secondary, tertiary or quartic video (H.264 only), JPEG capture can be selected for uploading.
- > Number of Frame
Enter frame number of JPEG capture. (1 ~ 10)
- > Capture Interval
Select the interval of captured frame.

SSL

The screenshot shows the SSL configuration interface. On the left is a sidebar with a tree view containing the following items: Video&Audio (+), Image (+), Network (-), IP&Port, Discovery, One-way, SNMP, DDNS, IP filtering, E-mail, FTP, Google Drive, SSL (highlighted), Connecting, Event (+), Record (+), Device (+), PTZ (+), User (+), and System (+). The main area is titled 'SSL' and contains the following configuration options: 'SSL Enable' is a dropdown menu set to 'On'; 'User ID' is a text input field; 'Password' is a text input field; 'VPN IP Address' is a text input field; 'VPN Port' is a text input field containing the value '0'; and 'Crypto Enable' is a dropdown menu set to 'Off'. An 'Apply' button is located at the bottom right of the configuration area.

- **SSL Enable**
SSL-VPN function will be enabled
- **User ID**
User ID on VPN Client
- **Password**
User Password on VPN client
- **VPN IP Address**
Set IP address on VPN
- **VPN Port**
Set the port on VPN
- **VPN IP Address**
Set IP address on VPN

Connecting

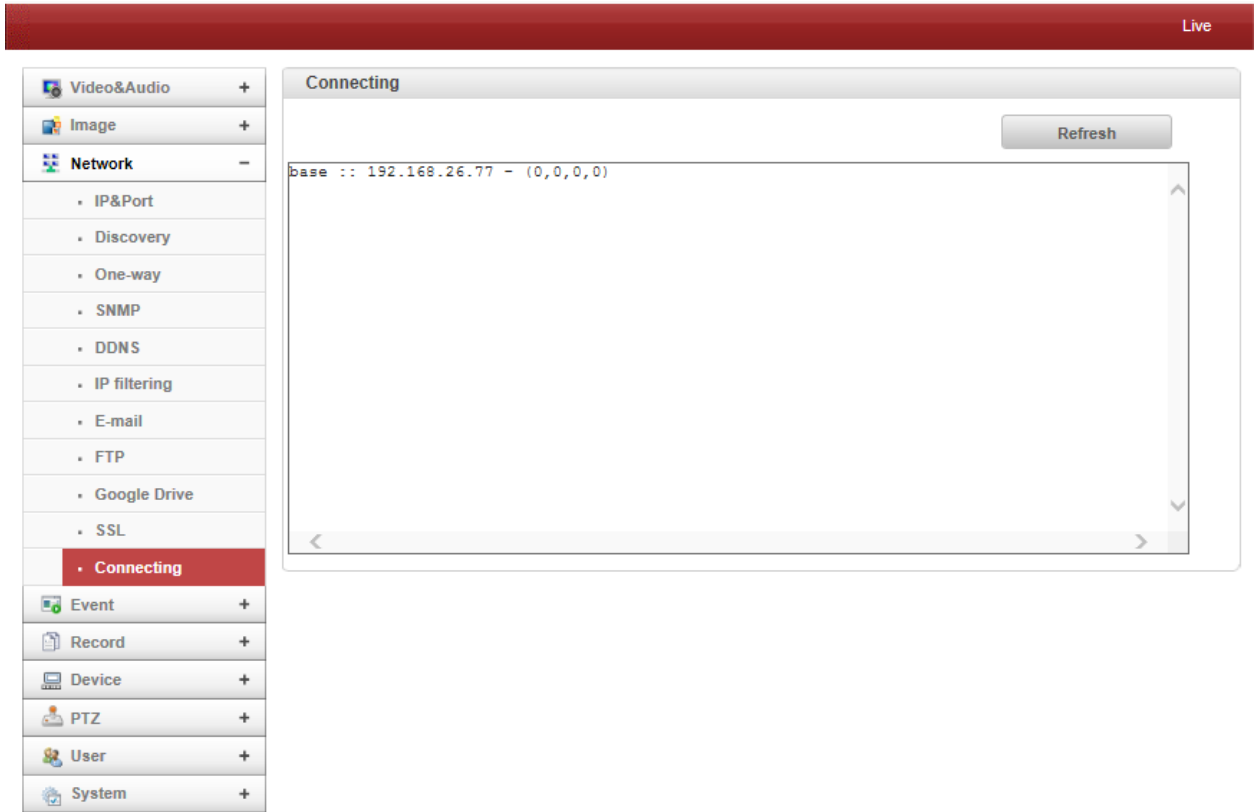

Client IP Addresses that are currently connected to system are listed. (1) Indicates

● **Event Notification**

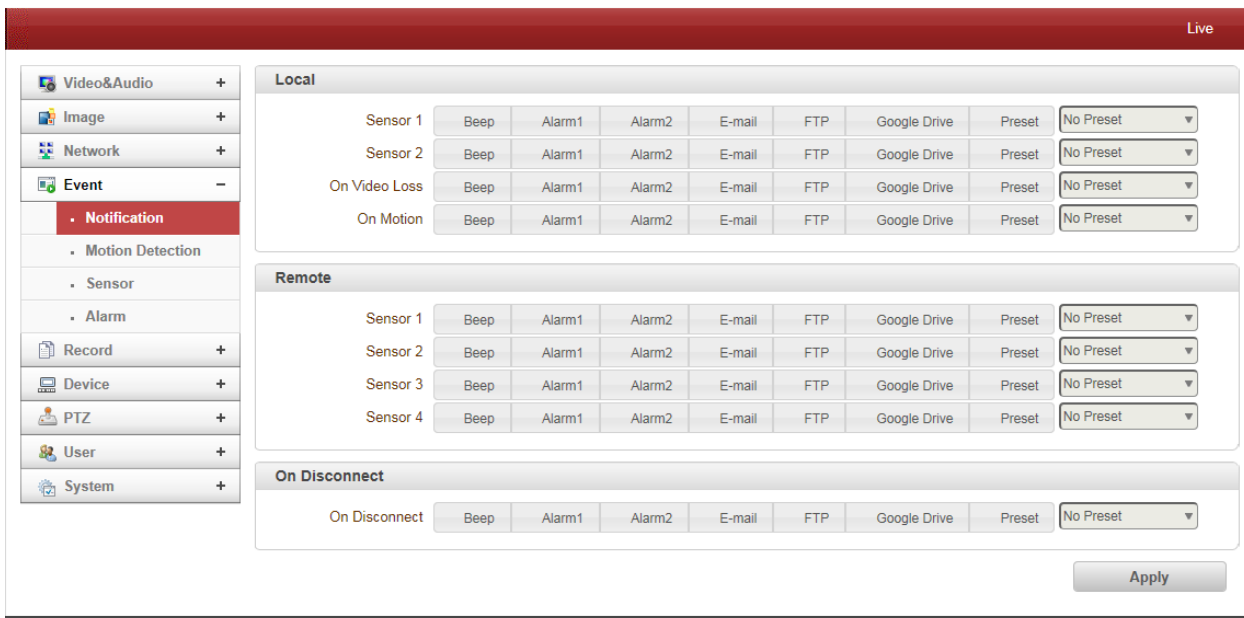

- **Local**

When a decoder instead of a PC client is connected to an IP camera, one system becomes a Local system and the other a Remote system (Generally a system which is being used by the user is called as Local system). Then, actions for events can be configured for events from the remote system as well as for local system. For example, it is possible to turn on an alarm device in local (center) decoder system when a sensor device in remote (site) IP camera is triggered. **Local** section configures the actions for events from local (self) system, and configuration activates local devices and **Remote** sections configure the actions for events from remote (peer) system.

The following table lists the possible actions for events.

Action	Description
Beep	Triggers beep port.
Alarm out	Triggers alarm (relay) port.
E-mail	Sends E-mail to the specified address. AVI file can be attached
FTP	Upload AVI file to a specified FTP server
Google Drive	Upload Google Drive storing through network
Preset	Move to the Preset position

- **Sensor1 / Sensor2**

Configure the actions when the sensor is activated. Multiple actions can be set for a single event.

- **On Video Loss**

Configure the actions when video input signal is lost. Multiple actions can be set for a single event.

- **On Motion**

Configure the actions when motion is detected. Multiple actions can be set for a single event.

- **On Disconnect**

Configure the actions when the link (connection) with peer system is disconnected. Multiple actions can be set for a single event. This event happens when the last client which has been receiving video from the camera loses the connection.

Motion Detection

- **Use Motion Detection**

Determine to use **Motion Detection** function.

- **Motion Detection Area Editing**

Configure region for motion detection. Regions of arbitrary shape can be configured by the following steps;

- I. Select **Enable** on **Edit** tab.
- II. Select editing mode. **Set** is for including cells to motion detection region and **Erase** is for excluding.
- III. Select cells by right click. Multiple cells can be selected by press and dragging.
- IV. Press **Apply Edit Area** to save the setting.

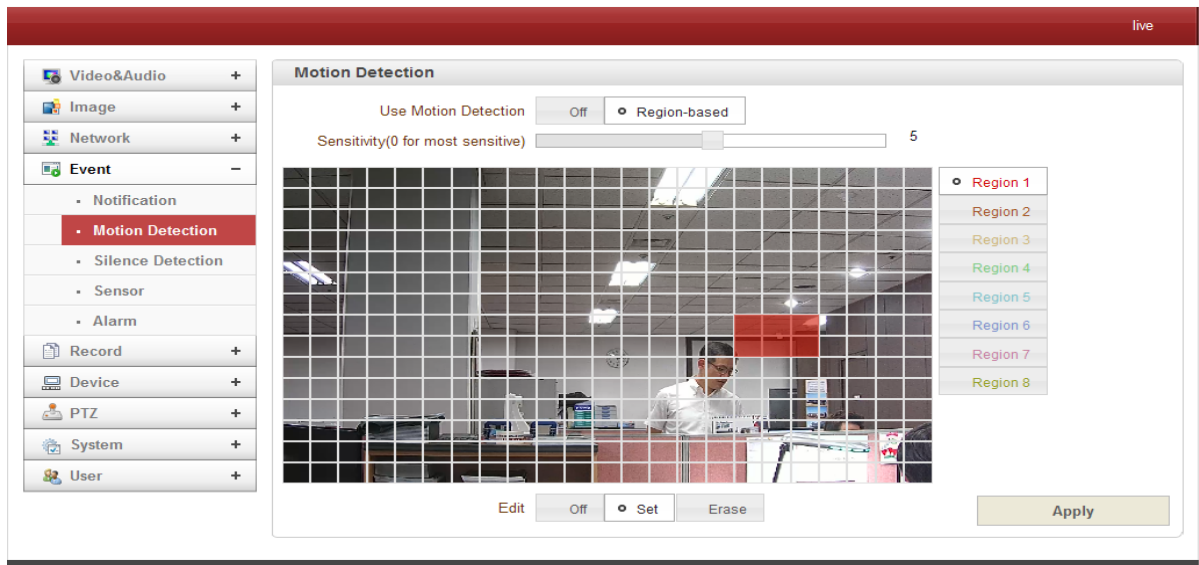

Sensor

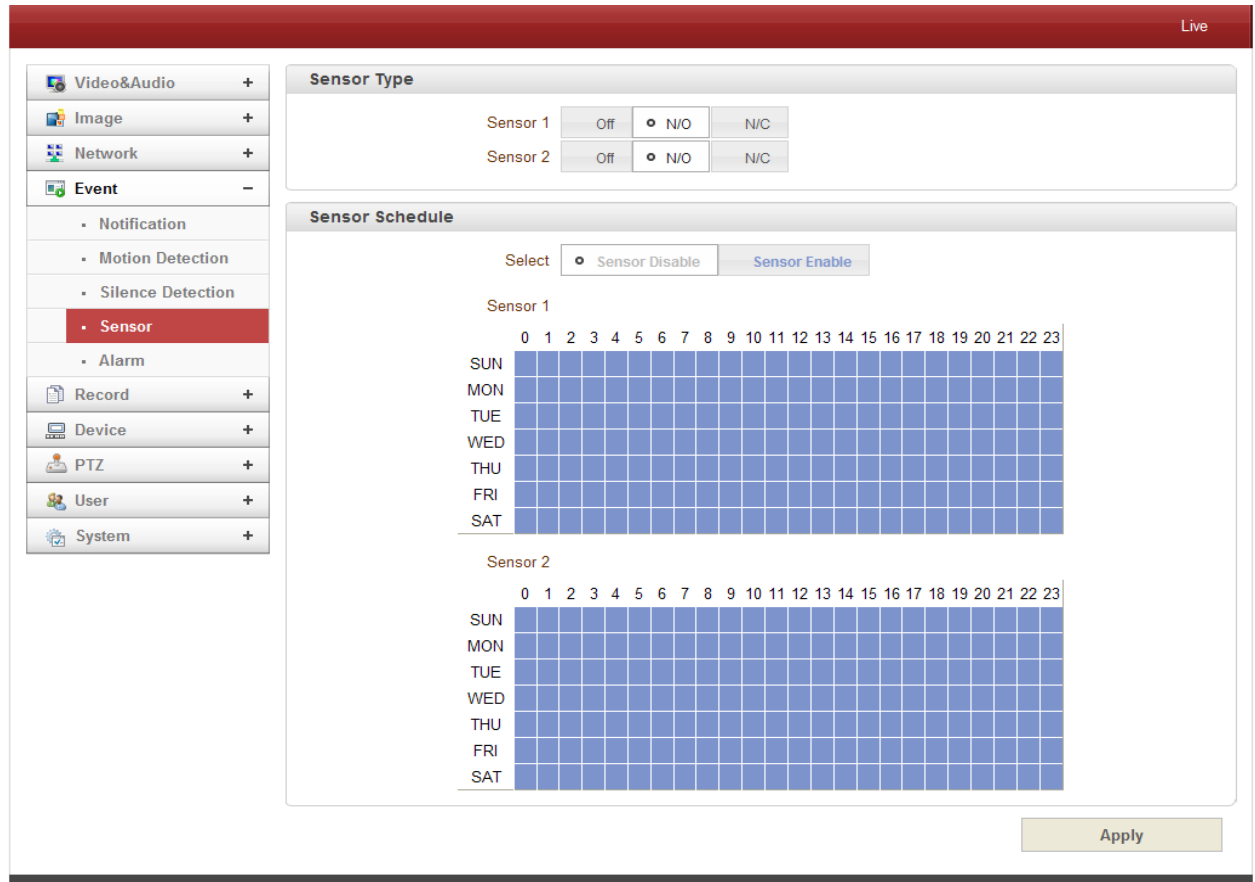

- **Sensor Type**

There are two sensor input ports on video server. Each of the sensor ports can be configured to the followings;

Function	Operation
OFF	Not used
NO (Normally Open)	The port is normally open and activated when closed.
NC (Normally Closed)	The port is normally closed and activated when opened.

The function of the sensor port is set based on the type of the sensor connected.

- **Sensor Schedule**

Choose **Sensor OFF** or **Sensor On** and click the below schedule table to make a sensor schedule according to day of week and hours.

Alarm

Set the duration of alarm or beep activation in case of an event. If it is set to **continuous**, it will be in active state until the operator resets it manually.

●Record
General

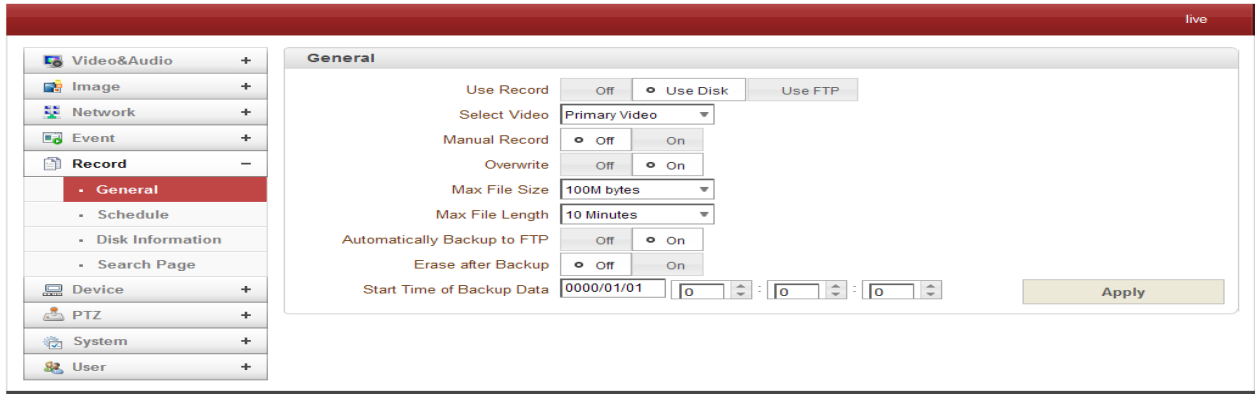

- Use record
 - Off : Recording function will not be used when “OFF” is selected.
 - Use Disk : Use disk function will follow the setting of Schedule table which set as record off as a default.
 - Use FTP : Recording will be enabled and data will be uploaded to an FTP server. In this mode FTP upload by event is automatically disabled.
- Select Video
 Select video stream to record.
- Manual record
 When On is selected, record is operated regardless of schedule.
- Overwrite
 When the disk becomes full, the oldest data are deleted automatically. It is valid only when Use Record is set to Use disk.
- Max File Size / Max File Length
 Max File Size option is for limiting the size of AVI file. If small file size is set, files of small size will be generated but numbers of the files will be increased. Max File Length option is for limiting the time length of AVI file. If the size of a file becomes Max File Size or the duration of the recording reaches Max File Length, a new file is created.
- Automatically Backup to FTP
 Data recorded in the disk can be uploaded to an FTP server automatically for backup. FTP server is configured on Event page. It is valid only when Use Record is set to Use Disk.
- Erase After Backup
 Data are deleted in the disk automatically after being uploaded to the FTP server. It is valid only when Automatically Backup to FTP is used.
- Start Time of Backup Data
 Specify the time of the data in the disk from which Backup to FTP Disk is performed. This time is changed automatically as the backup to FTP server goes. So it is useful to check current backup status. It is valid only when Automatically Backup to FTP is used.

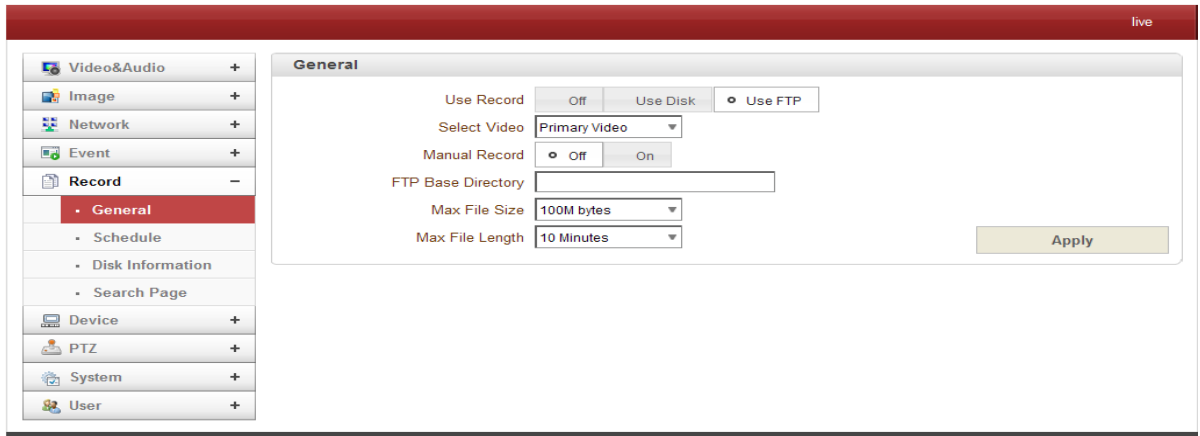

- **FTP Base Directory**
Specify the name of the directory to be created in the FTP server. It is valid only when Use Record is set to Use FTP.

Checking status of recording

Recording status can be checked on the main view page.



Schedule

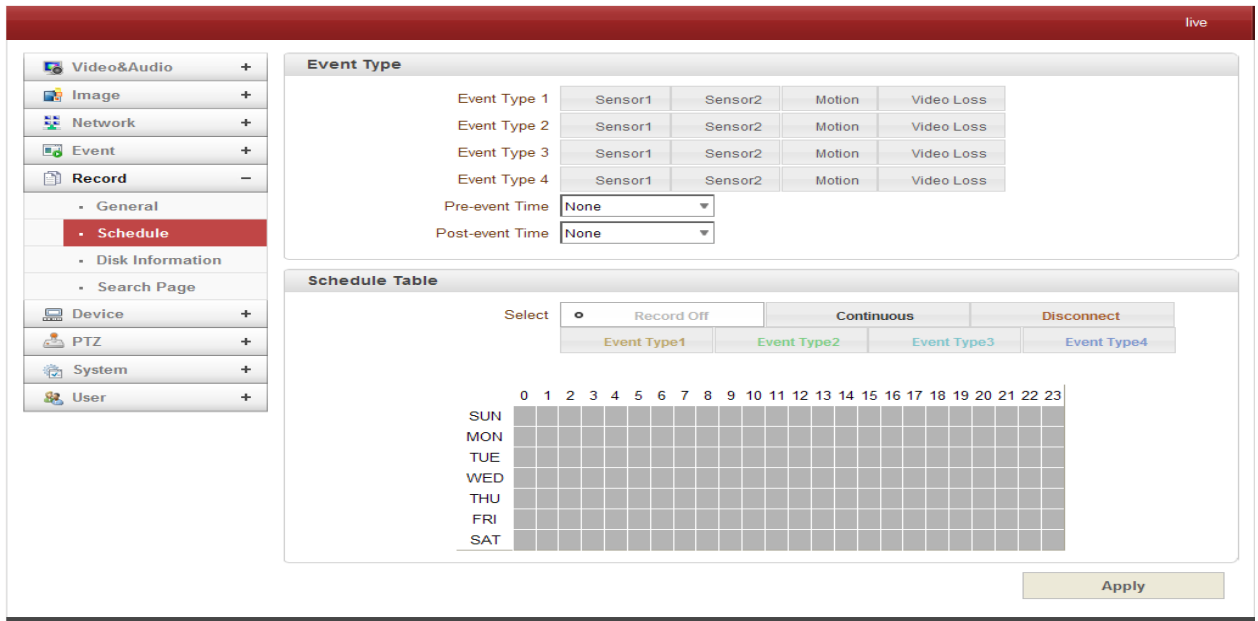

- Event Type
 - Three recording modes are supported: Continuous, Event, Disconnect. In case of Event recording, event types can be selected among several events. Selected event type is used for configuring the schedule table. Up to 4 event types can be configured and each event type can be a combination of sensor, video loss and motion event.
 - Pre-event Time
 - Specify the duration of recording before an event happens.
 - Post-event Time
 - Specify the duration after the event is cleared.
- Schedule Table
 - Actual recording mode is determined by **Schedule Table**, where recording mode configured by day (of a week) and hour.
 - Each of recording modes configures the recording operation as follows:
 - Record Off
 - No Recording
 - Continuous
 - Records continuously
 - Disconnect
 - Recording is started when the system loses the connection to its last client(Decoder, VMS/NVR) etc. When there are multiple clients and one of the client is disconnected, this doesn't happen.
 - Event Type
 - Records when an event configured in Event Type setting happens.

Disk Information

SD memory can be used, and at least 1GB size is recommended. Either EXT3 or FAT32 file system can be used. A disk with either EXT3 or FAT32 file system can be read in Linux PC. However, only disk with FAT32 file system can be read in Windows PC. Less than 4Mbps of video bit rate is recommended when you record and monitor video simultaneously since frame dropping may happen due to performance limitation.

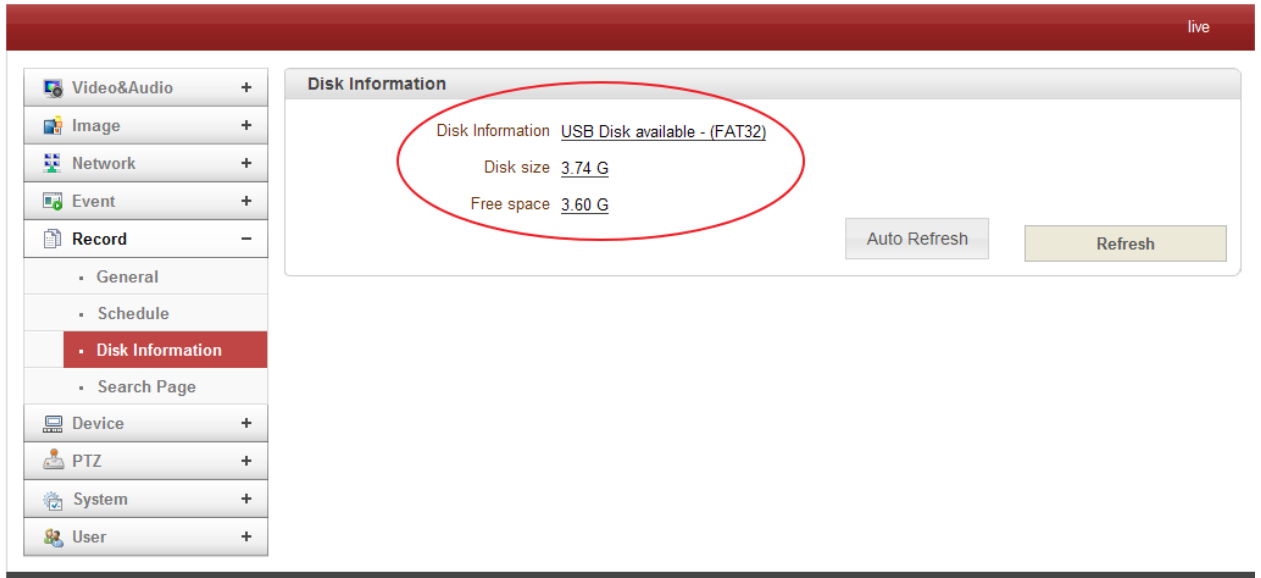

Be sure to restart the system after connecting an SD card. During booting, the system reads status of disk and initializes it. Once the initialization of a disk is finished, the status of disk is shown on **Record** page of web-based setup

Refer to the chart for checking the status of disk.

Disk status↕	Description↕
Disk error detected↕	Error↕
No disk ↕	Disk is not connected to the system.↕
Searching Disk information↕	Checking the status of disk. Refresh the page and wait until the status is changed.↕
Mounting and Recovering Disk...↕	Performing recovery process when disk damage is found. It takes from seconds to minutes for recovering.↕
Disk format needed ↕	Disk is attached, but the type of the file system is unknown or damaged.↕
Unknown disk type detected ↕	
USB Disk available↕	Available to be used for recording↕
Disk removed ↕ or in abnormal state↕	Disk is detached during operation or there is damage on the file system. If it happens while disk is connected, it is recommended to format the disk. ↕

Search Page

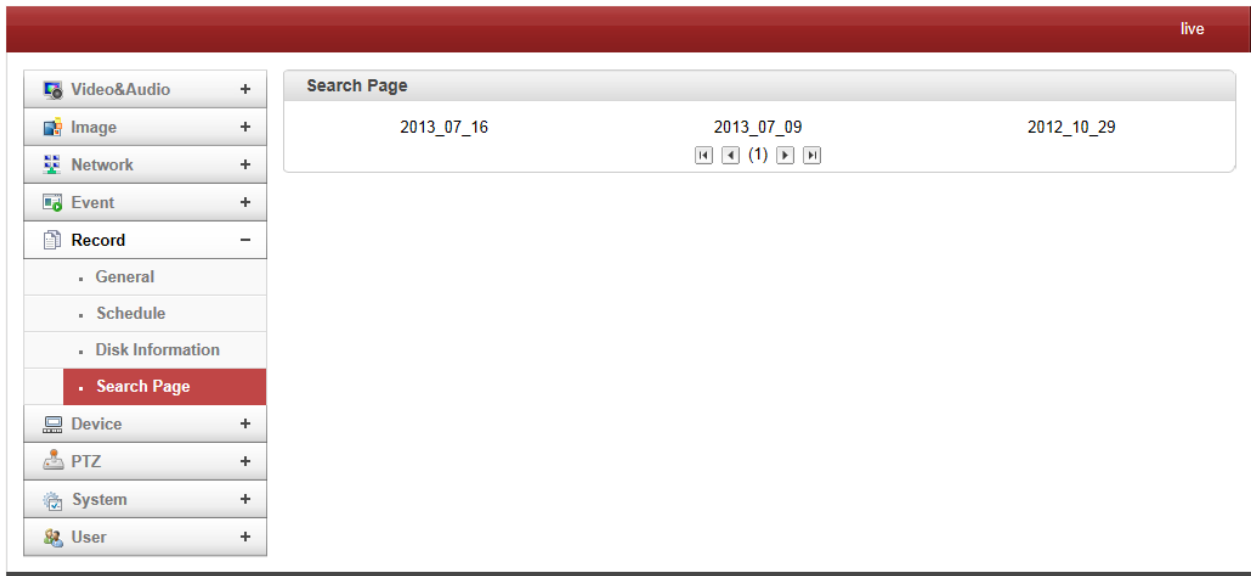

Recorded video and audio data can be saved as AVI format in the disk. In general, one AVI file is created for an event in case of event-based recording. However, it is possible that recorded data by serious of events happening continuously can be merged to a single AVI file depending on pre/post event time setting. The size of file is limited to 10 ~ 2GB. In case of continuous recording, AVI files are created in series and the size of each is limited to 10 ~ 2GB.

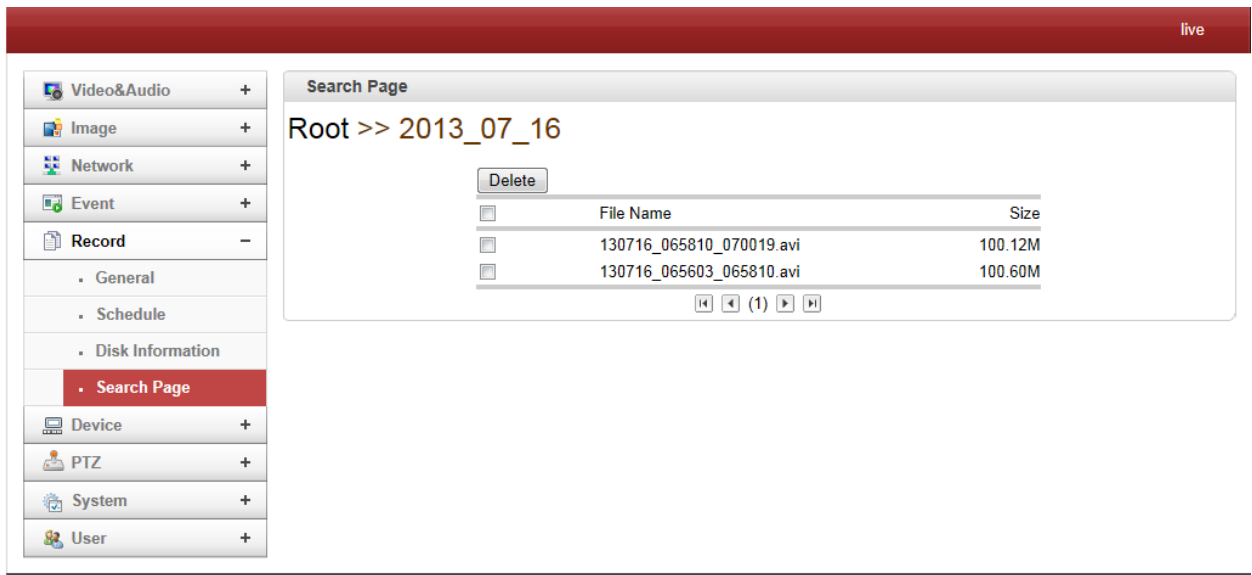

- **Playback**

1. Selecting an AVI file will show a dialog for opening or saving the file
2. Pressing **Save** button, the file will be stored in the PC. The AVI file can be played with Windows Media Player.

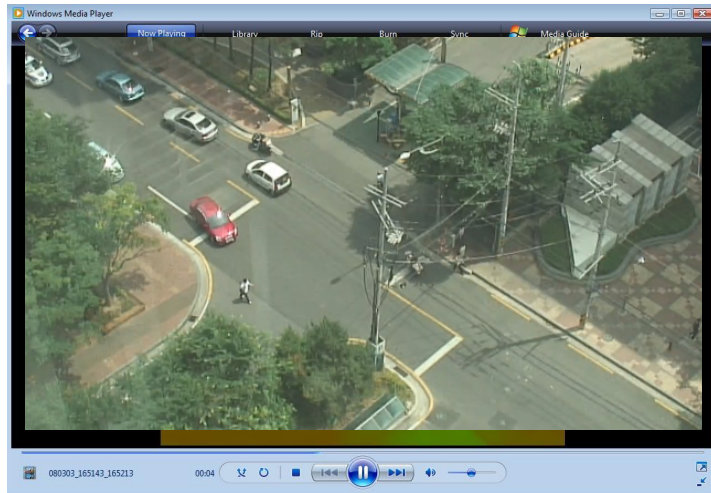

3. If you press **Open** in the dialog, the file will be downloaded and played automatically with Media Player.

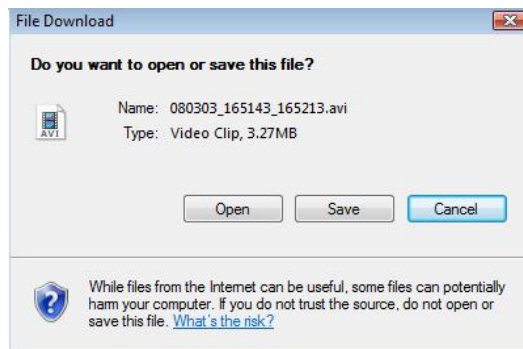

4. Another connection through web is disabled during downloading and it is also not allowed to download two AVI files at the same time.

● **Device Information**

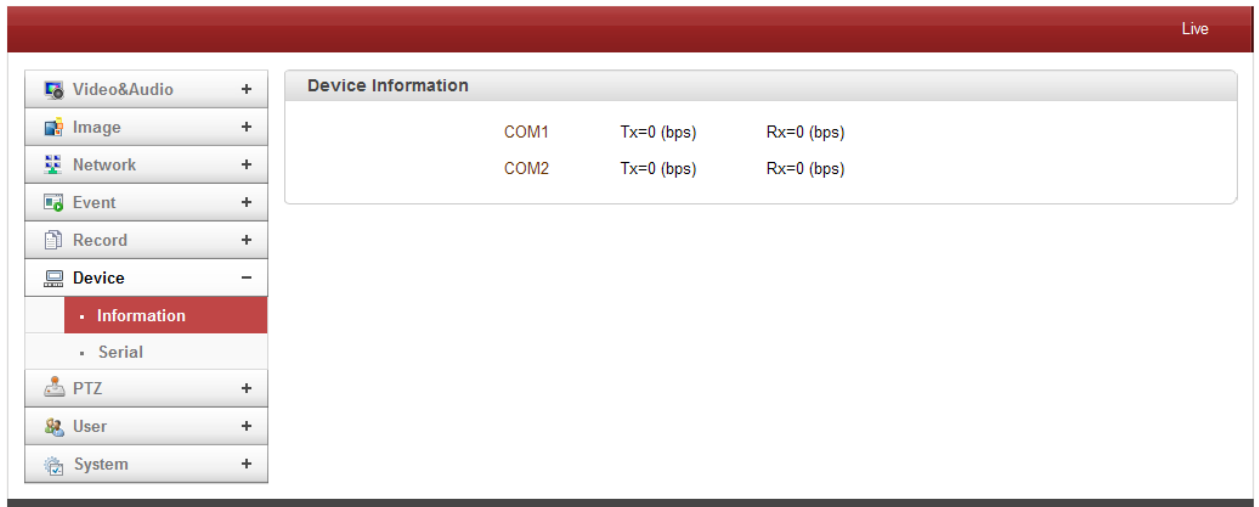

The information provides current serial communication status

Serial

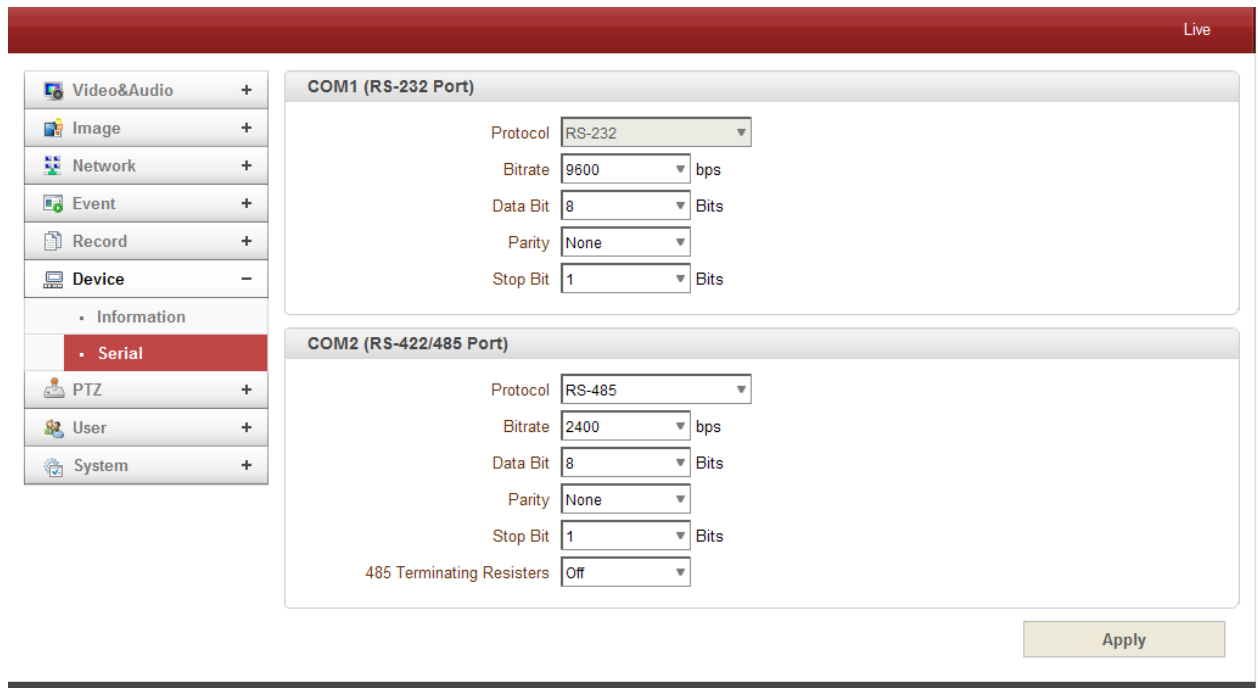

- **Serial Protocol :** There are two serial ports, RS-232, RS-422/485 in video server. Select RS-422 or RS-485 in RS-422/485 port
-
- **Serial Port Configuration:** The serial ports can be configured as follows.
Each of the serial ports configurations must be same as the connecting device

Mode [↕]	Selection [↕]
Bitrate [↕]	2400, 4800, 9600, 19200, 38400, 57600, 115200 bps [↕]
Data Bits [↕]	5, 6, 7, 8 bits [↕]
Parity [↕]	NONE, EVEN, ODD bit [↕]
Stop Bit [↕]	1, 2 bit [↕]

●PTZ
General

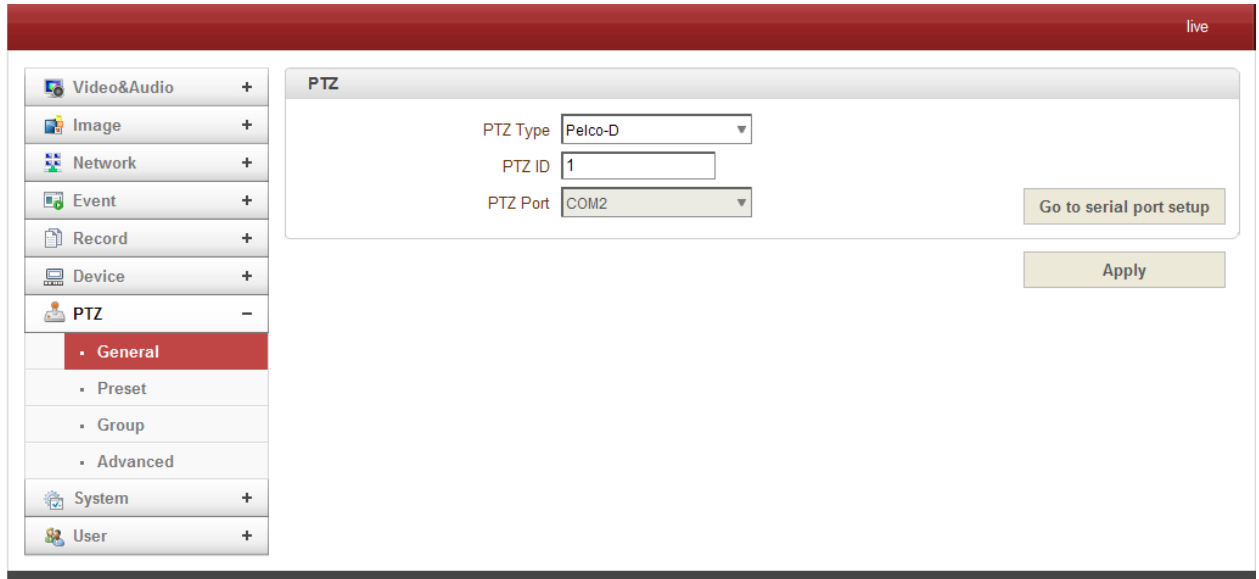

- **PTZ Type**
Select the type of PTZ camera or receiver.
- **PTZ ID**
Since it is possible to control multiple PTZ cameras or receivers over a single control line, each camera or receiver will be assigned with unique ID. Enter PTZ ID of a camera or receiver for control. The ID value range can be between 0 and 255.
- **PTZ Port**
Select the serial port for PTZ camera control.

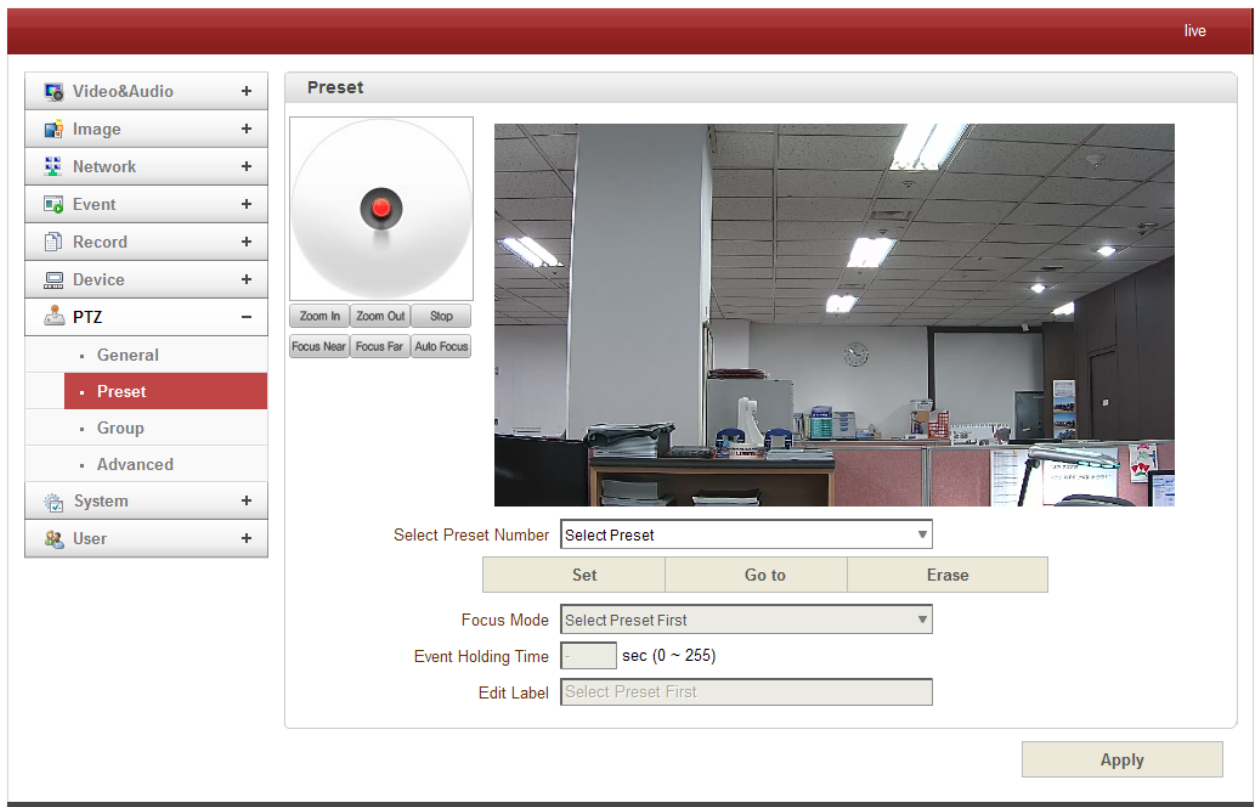
Preset

Max 128 preset positions can be defined.

- Select Preset Number: Select an entry in the list to be assigned to current camera position.
- Focus Mode: Select the focus mode after preset Goto is executed.
- Do not change: current focus mode is not changed.
- Focus Auto: auto-focusing is executed after the preset moved.
- Focus Manual: move to the focus position saved when preset set.
- Event Holding Time: Set the time to stay at the preset position when the preset moved by event.
If it is set to 0, the camera doesn't return to original position after moving to the preset position by event.
- Edit Label: Assign a label to the preset position. Only the first 15 preset entries (Preset-1 ~ Preset-15) can have labels.

Group

#1	#2	#3	#4	#5	#6	#7	#8
No.	Action	Dwell Time(0~255)	Option(0~255)	Enable			
1	No Preset	0 sec	Speed 0	<input type="checkbox"/>			
2	No Preset	0 sec	Speed 0	<input type="checkbox"/>			
3	No Preset	0 sec	Speed 0	<input type="checkbox"/>			
4	No Preset	0 sec	Speed 0	<input type="checkbox"/>			
5	No Preset	0 sec	Speed 0	<input type="checkbox"/>			
6	No Preset	0 sec	Speed 0	<input type="checkbox"/>			
7	No Preset	0 sec	Speed 0	<input type="checkbox"/>			
8	No Preset	0 sec	Speed 0	<input type="checkbox"/>			
9	No Preset	0 sec	Speed 0	<input type="checkbox"/>			
10	No Preset	0 sec	Speed 0	<input type="checkbox"/>			
11	No Preset	0 sec	Speed 0	<input type="checkbox"/>			
12	No Preset	0 sec	Speed 0	<input type="checkbox"/>			
13	No Preset	0 sec	Speed 0	<input type="checkbox"/>			
14	No Preset	0 sec	Speed 0	<input type="checkbox"/>			
15	No Preset	0 sec	Speed 0	<input type="checkbox"/>			
16	No Preset	0 sec	Speed 0	<input type="checkbox"/>			
17	No Preset	0 sec	Speed 0	<input type="checkbox"/>			
18	No Preset	0 sec	Speed 0	<input type="checkbox"/>			
19	No Preset	0 sec	Speed 0	<input type="checkbox"/>			
20	No Preset	0 sec	Speed 0	<input type="checkbox"/>			

This function is that the camera memorizes the combination of Presets, Pattern and/or Swings sequentially and runs Presets, Pattern and/or Swings repetitively on activation. Max 8 groups are programmable. Each group can have max 20 actions which are the combinations of Preset, Pattern and Swing. Option field has different meanings for Preset and Pattern/Swing. For Preset, it configures the preset speed.

For Pattern/Swing, it configures the number of repetition. Dwell time between actions can be set up as well.

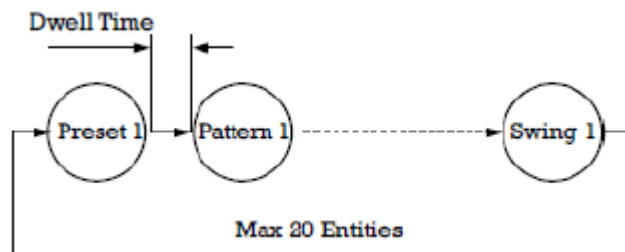

1. Select one of the entries of Group
2. Press Modify Group button. The following window will appear.
3. Set Action, Dwell Time and Option and click Enable squares
4. Press Apply button and the Group can be used on the Live View Page

Group

#1	#2	#3	#4	#5	#6	#7	#8	
No.	Action	Dwell Time(0~255)	Option(0~255)	Enable				
1	Preset-1	54 sec	Speed 77	<input checked="" type="checkbox"/>				
2	Preset-6	5 sec	Speed 124	<input checked="" type="checkbox"/>				
3	Preset-127	23 sec	Speed 55	<input checked="" type="checkbox"/>				
4	Preset-21	23 sec	Speed 43	<input checked="" type="checkbox"/>				
5	No Preset	0 sec	Speed 0	<input type="checkbox"/>				

Advanced

Live

- Video&Audio +
- Image +
- Network +
- Event +
- Record +
- Device +
- PTZ -
 - General
 - Preset
 - Group
 - Advanced
- User +
- System +

Advanced PTZ

Power Up Action Off Group-1 Preset-1

Auto Focus after Zoom Control Off On

Auto Parking

Parking Time sec (0~3600, 0:off)

Parking Action #1

Parking Action #2

Parking Action #3

Parking Action #4

Schedule of Auto Parking

	Parking Action#1	Parking Action#2	Parking Action#3	Parking Action#4																				
	0	1	2	3	4	5	6	7	8	9	10	11	12	13	14	15	16	17	18	19	20	21	22	23
SUN																								
MON																								
TUE																								
WED																								
THU																								
FRI																								
SAT																								

- **Advanced PTZ**
Specify if the camera will continue previous action such as pattern, swing or group after it is rebooted by power.

Page 56 of 69

56/69-

- > ON: If pattern, swing or group was running before rebooting, the action is resumed.
If it was in stopped state, it moves to the last position.
- > Off: Moves to the initial position after rebooting.
- Auto Parking
Auto parking is a function to return to the previous preset position or to resume operation such as Pattern, Swing or Group when a specified time expires after user stopped PTZ control. Parking time can be set from 0 to 3600 seconds and "0" means that Auto Parking function is turned off.

●User

User List

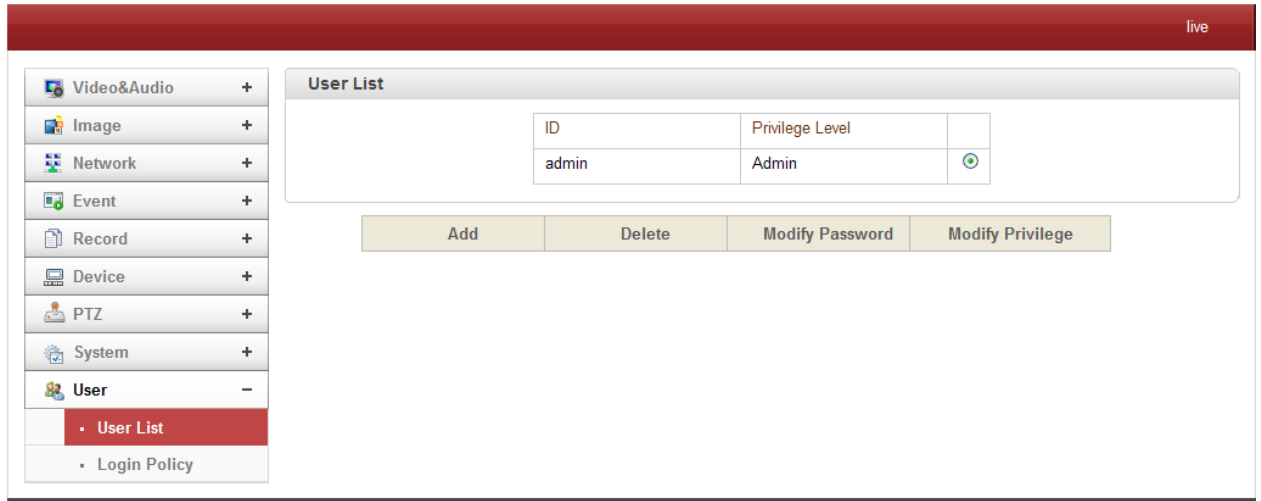

User can be registered and privilege level of a user can be specified. User configuration is allowed only to admin user. Max 16 users can be registered and each user can have one of four privileges.

Privilege	Allowed Operations	Remarks
Admin	All operations	User ID = admin
Manager	All operations except for user configuration	
User	Live viewing and PTZ control	
Guest	Live viewing only	

- **Add User**

Press **Add** button. The following window will appear.

Add User ✕

ID

Password

Confirm Password

Privilege Level

Add Cancel

Enter User ID and password (Up to 15 characters) and select **Privilege Level**.

- **Delete User**
Select the User to be deleted and press **Delete** button.

- **Change Password**
Press **Modify Password** button. The following window will appear.

Modify Password ✕

ID

Current Password

New Password

Confirm Password

Modify Cancel

Enter the current password and then set a new password.

- **Modify Privilege Level**
Press **Modify Privilege** button to change User level. It is not allowed to change the privilege level of admin user.

Modify Privilege Level ✕

ID

Privilege Level

Modify Cancel

Login Policy

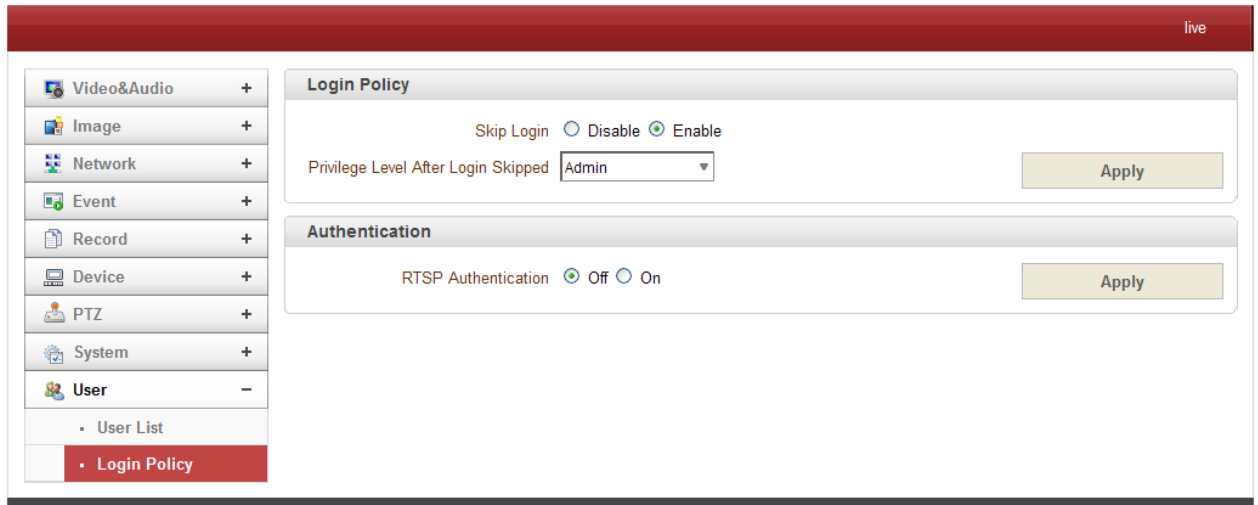

- **Login Policy**
Skip Login provides for convenient access to the server when authentication is not required. When Skip Login is set to **Enable**, login step is skipped. The privilege level after login in this way is determined by the setting of **Privilege Level After Login Skipped**.
- **Authentication**
 HTTP authentication based on RFC 2617(HTTP Authentication: Basic and Digest Access Authentication) is supported.

System Information

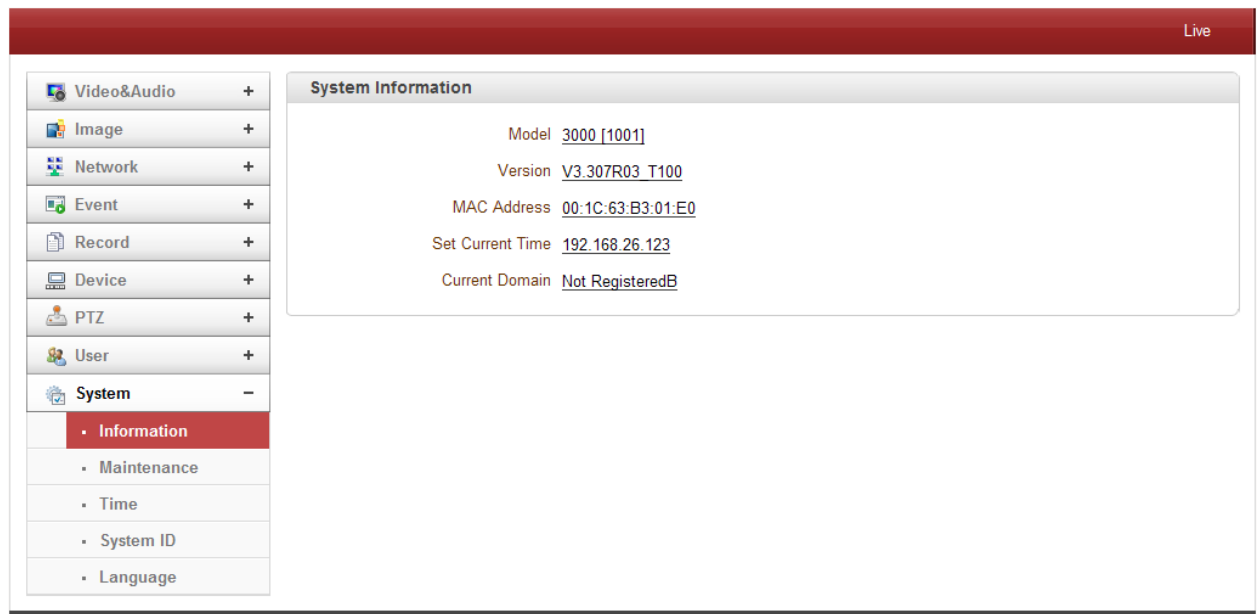

- System information
 Followed network information is displayed (Read only)
 - > **Model**
 Display the model name.
 - > **Version**

Display the current firmware version.

➤ **Mac Address**

Display the MAC address of the camera. In case the camera is registered at DDNS server, the MAC address is used in DDNS registration.

➤ **Set Current Time**

Display Current date and time

➤ **Current Domain**

In case the camera is registered at DDNS server, the registered domain name is displayed.

Maintenance

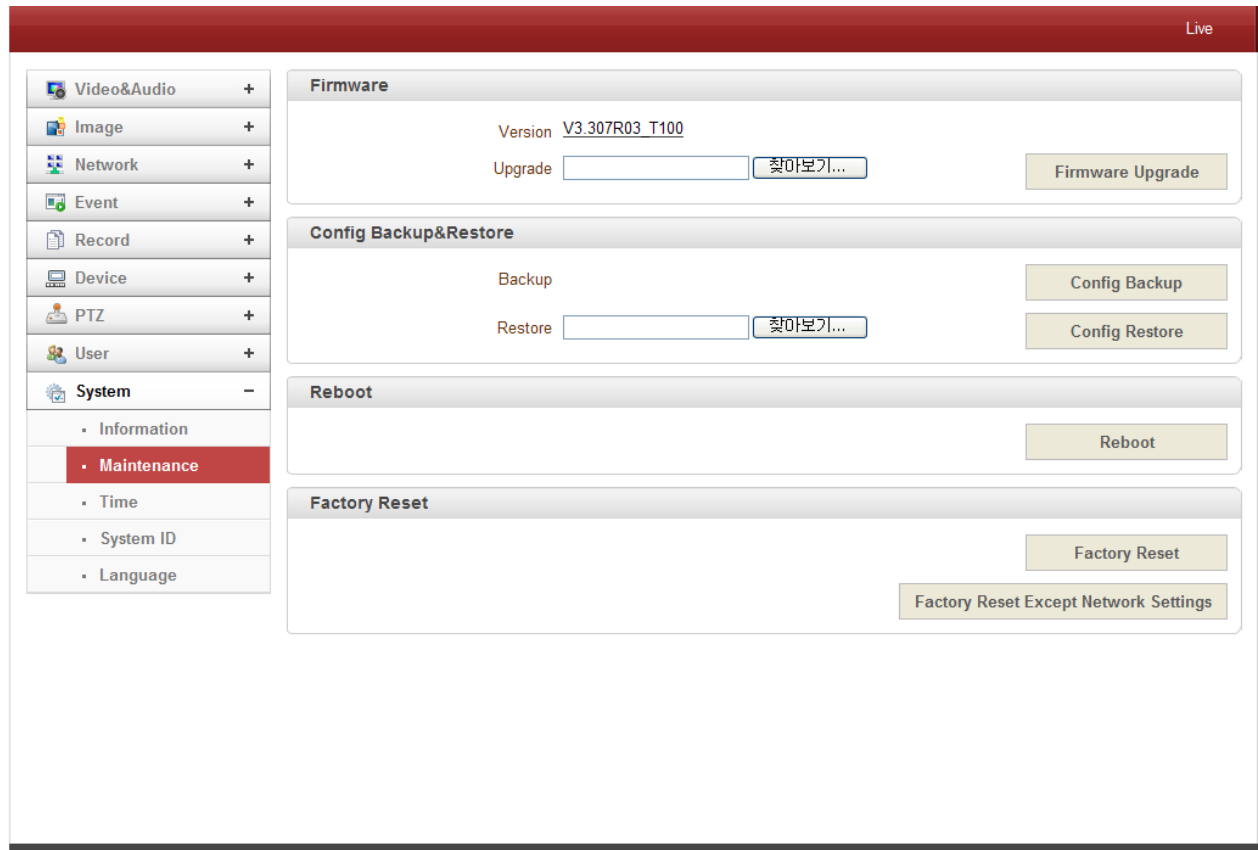

- Firmware

- > Version : Display the current firmware version
- Upgrade: To upgrade firmware;
 1. Press **Browse** button to select a firmware file from PC.
 2. Press **Firmware Upgrade** button to start upgrading.
 3. A message for showing status (downloading / upgrading) will be displayed.
 4. The camera will reboot automatically after completing upgrade.

Do not turn the camera off during upgrading.

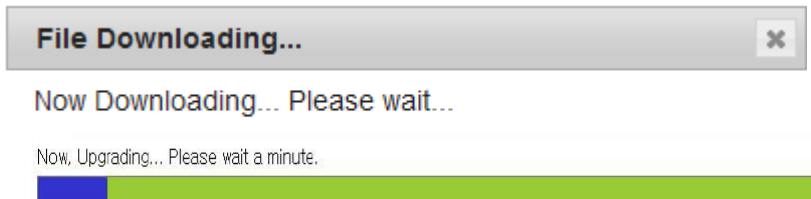

- Config Backup & Restore

- > Backup
 - All the setting of configuration can be stored.
- > Restore
 - Stored configuration can be browsed and restored. The server is rebooted once **Config Restore** button is pressed.

- Reboot
 - Reboot the camera
Do not press the Reboot button unless the server needs a reboot.
- Factory Reset
All settings including user accounts and logs are cleared
- Factory Reset Except Network Settings
All settings except for current network settings are changed to the default values.

Time

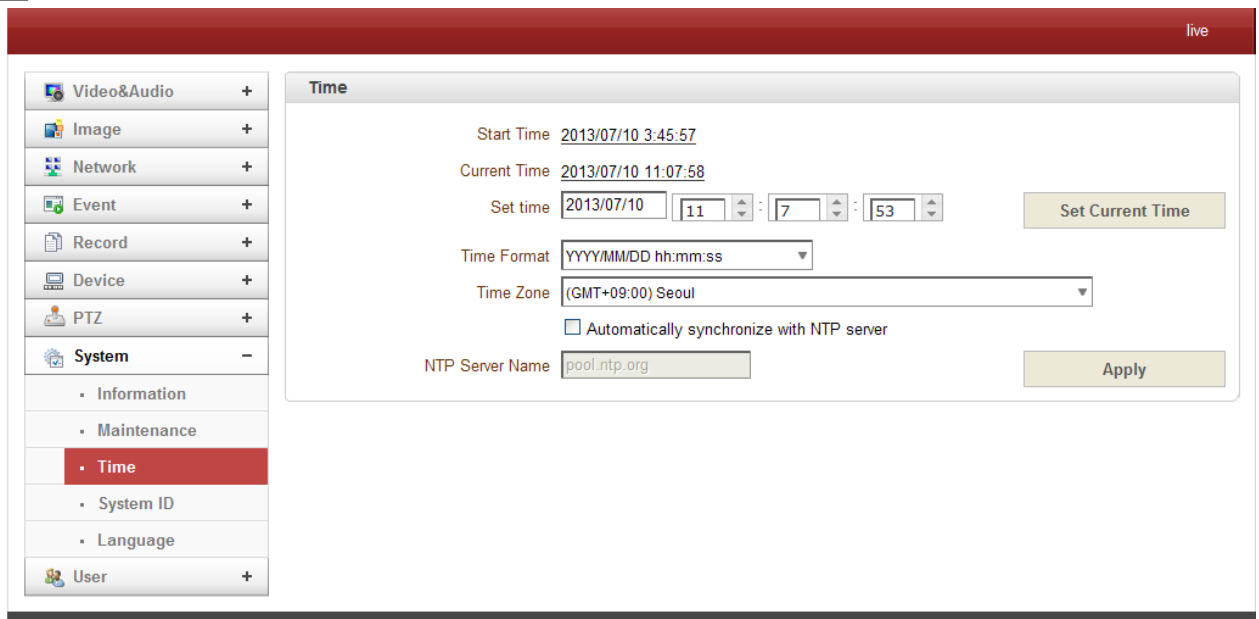

- **Start Time**
The latest the camera's booting date and time.
- **Current Time**
Current date and time.
Enter a new date and time then press **Set Current Time** button to update date & time.
- **Time Format**
Change the time format. The selectable time formats are as below;
 - I. YYYY/MM/DD hh:mm:ss (Eg. 2012/10.30 12:30:45)
 - II. DD/MM/YYYY hh:mm:ss (Eg. 10/30/2012 12:30:45)
 - III. MM/DD/YYYY hh:mm:ss (Eg. 30/10/2012 12:30:45)
- **Time Zone**
Select time zone of where the camera is installed.
Depending on the time zone, Daylight Saving Time will work automatically

A **time zone** is a region of the earth that has uniform standard time, usually referred to as the **local time**. By convention, time zones compute their local time as an offset from UTC (Coordinated Universal Time). In casual use, GMT (Greenwich Mean Time) can be considered equivalent to UTC. Local time is UTC plus the current time zone offset for the considered location

➤ **Automatically synchronized with NTP server**

Synchronize the camera time with an NTP server using NTP (network time protocol).
Name of the NTP server should be registered on NTP server Name.

The **Network Time Protocol (NTP)** is a protocol for synchronizing the clocks of computer systems over packet-switched, variable-latency data networks. It is designed particularly to resist the effects of variable latency by using a jitter buffer.

System ID

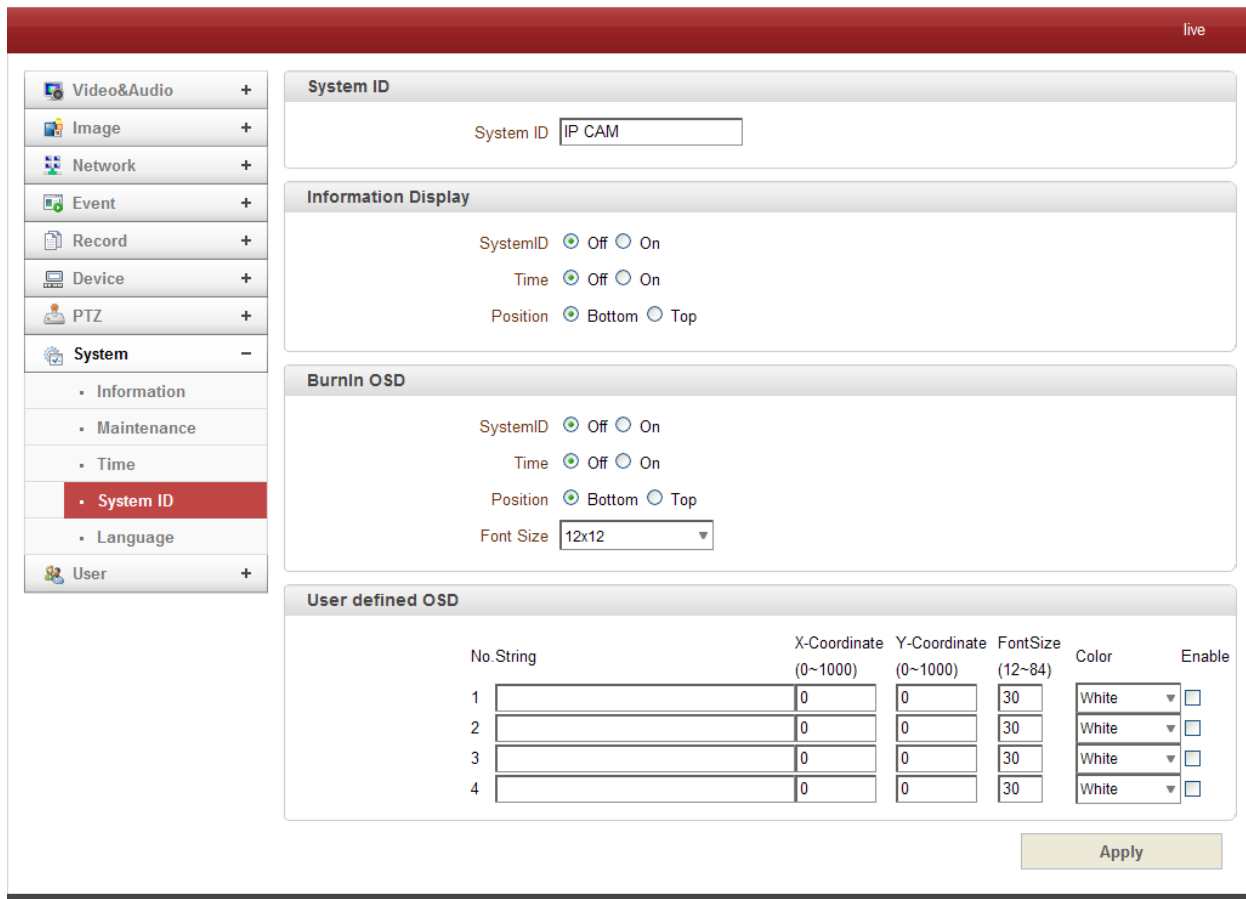

- **System ID**

Enter System ID that is used as a camera title.
The set System ID is displayed with video image on a Web Browser. The System ID is also transferred to remote software, such as VMS, and displayed on it.

- **Information Display**

System ID and/or server time can be display over the video window in Internet Explorer. Each item can be turn on or off separately, and position also can be configured. This information is displayed **after the video is decompressed**.

- **BurnIn OSD**

Insert system ID and date/time **in the compressed video**. System ID and time respectively can be turned on or off in the video. Position and Font size can be configured also. System ID for BurnIn OSD exists independently from normal System ID.

Note that size of Burnin OSD display varies according to the encoding resolution setting. This is inevitable because Burnin OSD is inserted to the frames before encoding is performed. The following table describes the rule for BurnIn OSD display.

Resolution [↕]	Small (8x8) [↕]	Middle (16x16) [↕]	Large (32x32) [↕]
352x480 / 352x240 / 352x576 / 352x288 [↕]	2 [↕]	1 [↕]	0 [↕]
720x480 / 720x240 / 720x576 / 720x288 / [↕] 640x480 / 800x600 [↕]	2 [↕]	2 [↕]	1 [↕]
1024 x 768 / 1280x720 / 1280 x 960 / 1280x1024 / 1440x900 / 1600x900 / 1680x1050 / 1920x1056 / 1920x1080 / 2048x1536 / 2560x1600 / 2592x1936 [↕]	2 [↕]	2 [↕]	2 [↕]

- 2 : Both System ID and Time are displayed
- 1 : Either System ID or Time can be displayed. When both are enabled, System ID is displayed.
- 0 : No items are displayed. This is because video area is too small to display OSD text in large text.

- **User defined OSD**

You can enter any text you like independent.

➤ X-Coordinate or Y-Coordinate

For example, if you enter 500, 500 values, OSD is placed in center of images.

Language

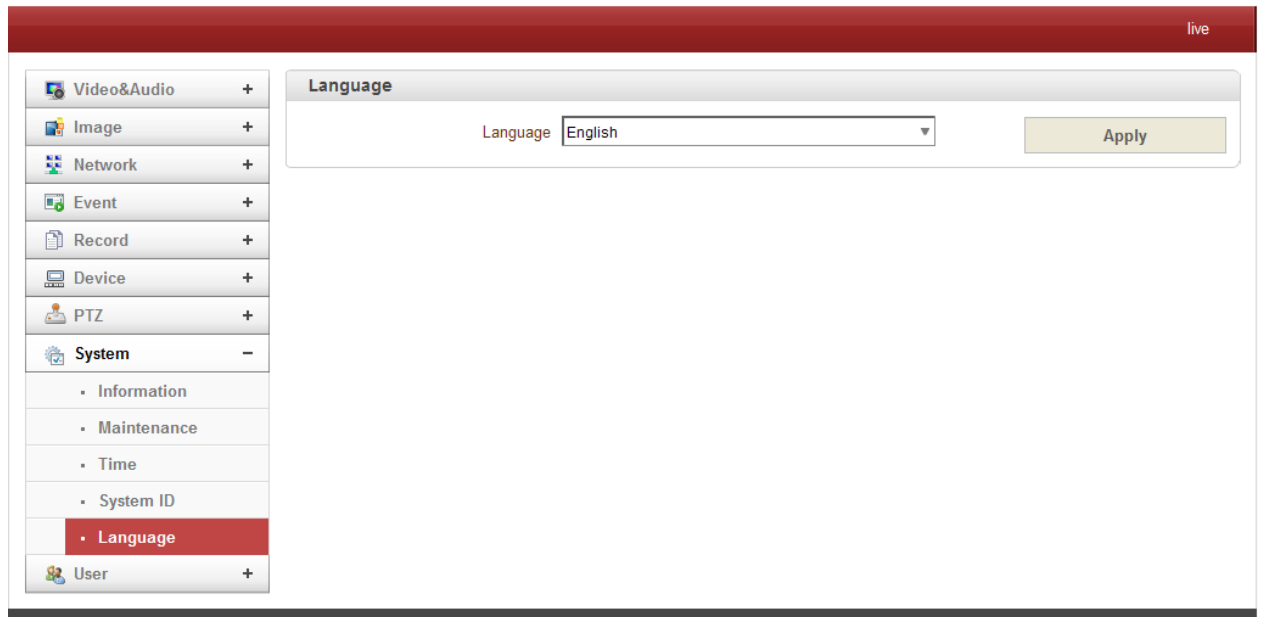

- Language
Select the language to be used for web-based configuration.

Appendix A : Sensor and Alarm Port

Sensor Port

- **Terminal Type**
 - Voltage Rating: 150VAC
 - Current Rating : 2A
 - Color : Red
- **Sensor Signal Input Type**
 - NO Contact Signals
- **Connection to External Device**

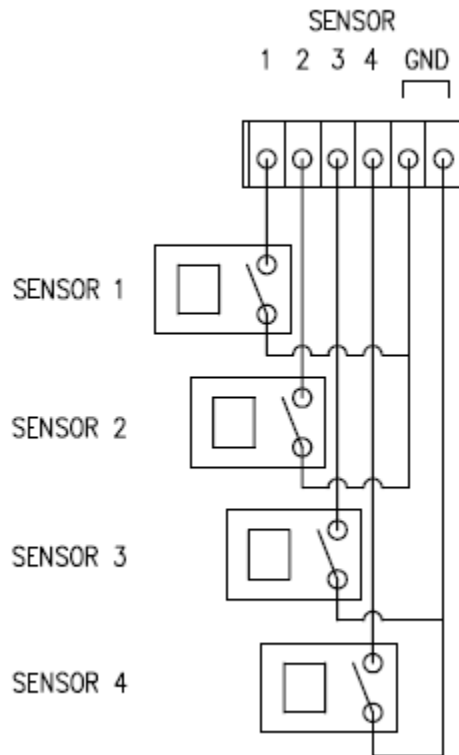

Alarm Port

- **Terminal Type**

- Voltage Rating: 150VAC
- Current Rating : 2A

- **Relay Type**

- Contact Rating : 1A 30VDC
- Switching Power : Max 30W 62.5VA
- Switching Voltage : Max 60VDC

- **Alarm Signal Output Type**

- NO/NC Contact Signals

- **Connection to External Device**

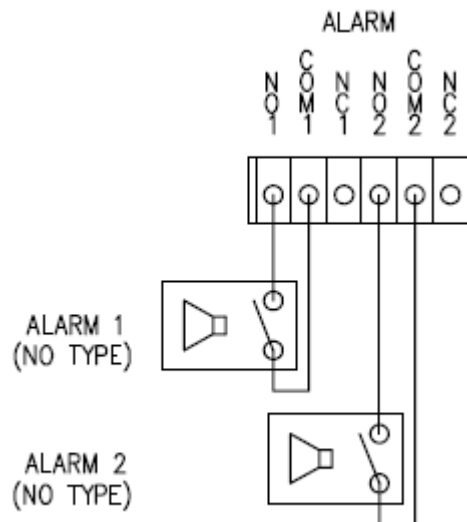

Appendix B : Serial Port

RS-232 Port

- **Port Type**
- 3 PIN
- Pin Arrangement

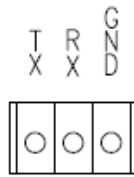

RS-232

- Pin Description

Pin NO	Pin Name	Description
1	TX	RS232 TX(Transmit)
2	RX	RS232 RX(Receive)
3	GND	Ground

RS-422/485 Port

- **Port Type**
- 4 PIN
- Pin Diagram

RS-422/485 TERMINALS



- Pin Description

Pin No.	Pin Name	Description
1	RX-	RS422 RX-
2	RX+	RS422 RX+
3	TX-	RS422 TX- or RS485 TRX- It is selectable by S/W Setup

4	TX+	RS422 TX+ or RS485 TRX+ It is selectable by S/W Setup
---	-----	--