



ANTRICA

encoders | decoders

User guide for

ANT-35100A

1080p60 Video Encoder

H.265/H.264 Encoder (HDMI and 3G/HD-SDI version)



Please note the images of the ANT-35100A used in the document are representations of the finished items, and the enclosure you have may be a different design and colour.

For further help and advice please contact **Antrica** on:

Email: support@antrica.com

Phone: +44 1628 626098, during UK office hours, and
ask for technical support

Document info

Version	date	author	Comments
1.0	12-Dec-23	K Y J	Initial draft
1.1	13-Mar-25	David M	Update some image and minor text / layout changes

Safety Precaution

**We appreciate your purchasing video server.
Before installing the product, please read the following with care.**

- ✧ Make sure to turn off the power before installing video server.
- ✧ Do not install under the direct sunlight or in dusty areas.
- ✧ Make sure to use the product within the temperature and humidity specified in the specification.
- ✧ Do not operate the product in presence of vibrations or strong magnetic fields.
- ✧ Do not put electrically conducting materials in the ventilation hole.
- ✧ Do not open the top cover of the products. It may cause a failure or electric shock on the components.
- ✧ To prevent from overheating, make sure to keep the distance at least 10cm from the ventilation hole.
- ✧ Make sure to check the proper voltage before connecting the power.

1. Introduction	4
About this manual	4
Features	4
Product and Accessories.....	5
Part Names and Functions.....	6
System Connections	9
2. Installation	11
Connecting Video	11
Connecting Audio.....	11
Connecting Serial Ports.....	11
Connecting Sensor and Alarm.....	11
Connecting Power	11
Check if it Works	11
Front LED display and button	12
3. System Operation	13
Remote Video Monitoring	13
4. Remote Configuration.....	18
Using Web Browser	18
Video & Audio	19
Image	25
Network	26
Event.....	42
Record.....	48
Device	54
PTZ	55
User	59
System	63
Appendix A : Sensor and Alarm Port	69
Appendix B : Serial Port	71

1. Introduction

About this manual

This User Manual provides information on installation setup and operation of the video server, as well as how to manage troubleshooting.

Features

A Video server is a video and audio transmission system that provides broadcast quality audio and video, based on IP network through LAN and ADSL/VDSL. Video server operates in an Encoder mode. Encoder system compresses media data and transmits them.

Video

- Up to 1920x1080 p60
- Highly efficient compression algorithm, H.265 / H.264 / MJPEG support
- Wide range of transmission rates: 32kbps ~ 16Mbps
- Various transmission modes: CBR, VBR, Hybrid
- Motion detection

Audio

- Multi-Transmission Mode : Unidirectional Mode (IP-server to Client PC or Decoder / Client PC or Decoder to IP-server), Bi-directional Mode

Network

- Fixed IP & Dynamic IP (DHCP) support
- 1:1, 1:N support
- Multicasting
- MPEG-TS
- SRT (Secure Reliable Transport)
- Automatic transmit rate control according to network conditions
- OnVIF, PSIA compliant

Serial Data

- RS-232/422/485 support
- Data pass-through mode : Serial data communication between IP camera and Decoder
- Data pass-through mode : Serial data communication between Encoder - Decoder

Sensor and Alarm

- Support direct connections of external sensor and alarm devices
- Event Alarm

USB

- Connection to internal or external USB storage for remote access, recording and playback

User Interface

- Diagnose and upgrade through dedicated program called True Manager
- System configuration using web browser

High Reliability

- Reliable embedded system
- System recovery by dual watch-dog functions

Product and Accessories



Video Server



Quick Manual

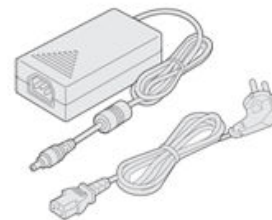

Power Adapter and Cable

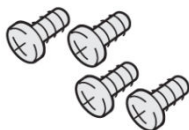

Screws

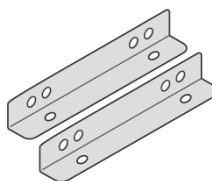

Brackets

Part Names and Functions

Front View



No.	Parts	Function
①	LED	Display system status
②	Audio Input	Audio Input
③	Audio Output	Audio Output
④	USB Port	USB 2.0
⑤	Ethernet/802.3af	1000/100/10MB Base-T Ethernet
⑥	Reset Button	Initialization of network setting

Rear View



No.	Part	Function
①	Power	DC +12V power input
②	RS-232	Serial port for PTZ control and etc
③	RS-422/485	Serial port for PTZ control and etc
④	Sensor	Sensor Input
⑤	Alarm	Alarm or Relay Output
⑥	3G/HD/SD-SDI In/Output	3G/HD/SD-SDI Video & Audio Input / Output
⑦	HDMI Input	HDMI Video & Audio Input
⑧	HDMI Output	HDMI Video & Audio Output

System Connections

Video server operates as one mode; Encoder. Video server can be connected in either 1-to-1 fashion where one encoder is connected one decoder or 1-to-many fashion where one encoder connected to many decoders.

Following chart shows data status of video, audio and serial data.

System Mode	Video	Audio	Serial Data
Encoder	Transmit	Transmit/Receive	Transmit/Receive

The system mode is defined by the video communication and the system mode is capable of single directional transmission of audio and bi-directional of serial data.

Topology

Generally, the encoder and a decoder are connected in 1-to-1 mode. To support specific situation, 1-to-multiple connection is also supported.

- **1:1 Connection (Unidirectional Transmission).**



The most commonly used configuration is 1 to 1 connection. An encoder is installed at a site where video images can be transmitted and a decoder is installed at a center location to receive and view the video images on monitors. Audio and serial data are transferred in either direction.

A decoder and encoder can be connected by setting of the encoder's address at the decoder's remote IP.

- **1:N Connection (Unidirectional Transmission).**

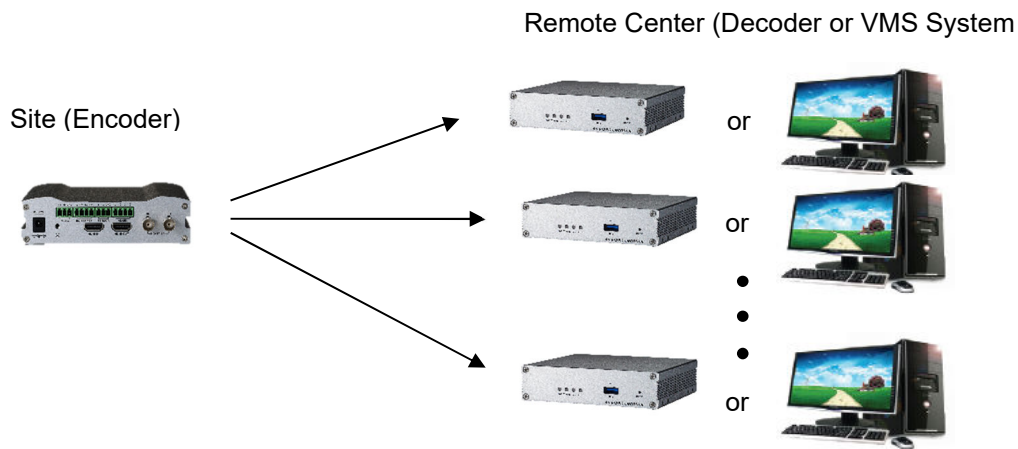

In this configuration, a site can be monitored from many remote center locations. Maximum connections would be limited by the network bandwidth.

Functionally, the VMS (Video Management System) software can be replaced as the decoder.

Multicast Mode

In the network supporting multicast mode, if **Multicast** is setup as a system protocol, you can use bandwidth efficiently regardless of the number of decoders. In 1:N connection, a large number of decoders can receive audio and video data from an encoder by using a single streaming transmission.

- **Relaying**



In this arrangement, video and audio can be retransmitted from a center to another center. The arrangement is useful when the network bandwidth at the site is limited while there is more than one center wanting to monitor the site.

- **VMS(Video Management System)**

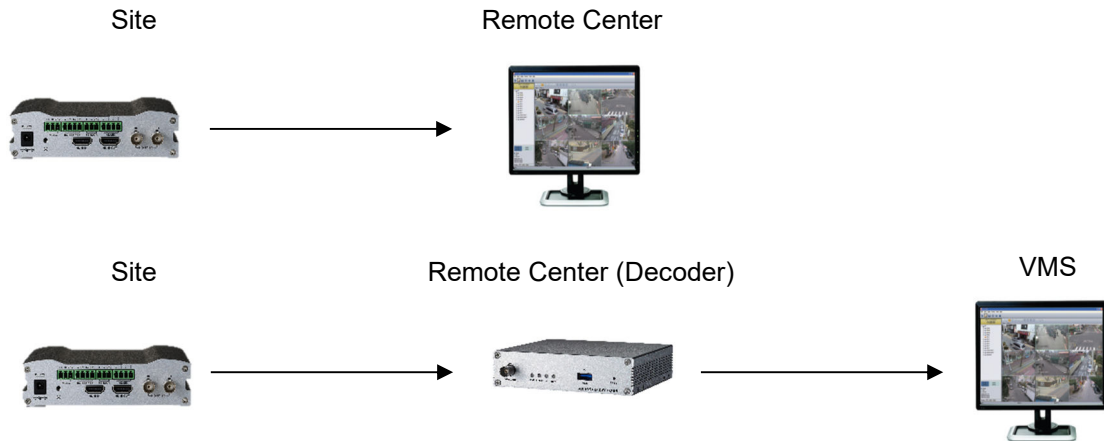

VMS (Video Management System) that supports Onvif is a Windows based remote monitoring program to access multiple encoders for real-time monitoring or control of the encoders and connected cameras.

2. Installation

Connecting Video

- Encoder system mode

Connect camera or other video source such as computer's video output line to the encoder (video server) video input port. HDMI cable ver. is 2.2.

Connecting Audio

It is possible to set the mode as Tx-only, Rx-only, Tx-Rx or audio off.

- Connect audio input and output ports to audio devices accordingly.
- The Audio signal required is line level, so audio equipment with an amp, mixer or other amplifier should be used.
- Embedded audio over HDMI is supported.

Connecting Serial Ports

- For camera control, PTZ controller (keyboard) and receiver can be connected to serial ports. Two corresponding serial ports in encoder and decoder which are connected in 1-to-1 fashion works in pass-through mode. This means that commands at a local system's COM1 port will be transparently passed to the remote system's COM1 port. Also, a command at a local system COM2 port will pass to the remote system's COM2 port.

Connecting Sensor and Alarm

- Connect sensor and alarm devices to corresponding terminals accordingly.

Connecting Power

- After confirming the power source, connect power adaptor and connect the 12VDC connector to the system.
- Also PoE (Power over Ethernet) is supported.

Check if it Works

- Once the power is supplied to the camera, it will start booting. The system will boot up to an operating mode after approximately 40-60 seconds. The green LED on the Ethernet port will flash indicating the system is ready. Software called True Manager allows you to check the IP address and other network details of the camera. Please refer to the True Manager manual for instructions on how to find the IP address of the camera and if required changing it.

Front LED display and button

<input type="radio"/> PWR	<input type="radio"/> STATUS	<input type="radio"/> LAN	<input type="radio"/> HDMI		<input type="checkbox"/> USB3.0	<input checked="" type="radio"/> Rec BTN	<input type="radio"/> BTN Status
---------------------------	------------------------------	---------------------------	----------------------------	--	---------------------------------	--	----------------------------------

- Description of LED

PWR STATUS LAN HDMI

System status can be monitored with LED display

LED	State	Description
PWR	Off	Power off
	Green	Power on
STATUS	Green blinking	Normally operating
	Red	System failure: Needs diagnostics
LAN	Off	No LAN connection
	Green	LAN Connected
HDMI (Encoder)	Green	HDMI Connected
	Red	HDMI Connection failure
	Off	No HDMI connection

- USB 3.0: USB Recording

- Description of USER KEY

	State	Description
Rec Button	On	Starts recording on USB
		To use this function, <Menu – Record – General – Use Disk – Manual Record – Button> should be selected.
Button Status	Green	Recording
	Off	Recording is off

3. System Operation

Remote Video Monitoring

- There are two ways to monitor video when the center system and IP camera are connected. In order for a proper operation, an IP address must be set accordingly. Default password is requested modification for better security. Please refer to True Manager program for further details.

- **Default ID** : admin
- **Default Password** :1234

Video Monitoring using Google Chrome

- Open Google Chrome and enter camera's IP address. Once authorized, Google Chrome will start to display video images from camera as shown below.

- **Default IP Address** : http://192.168.10.100

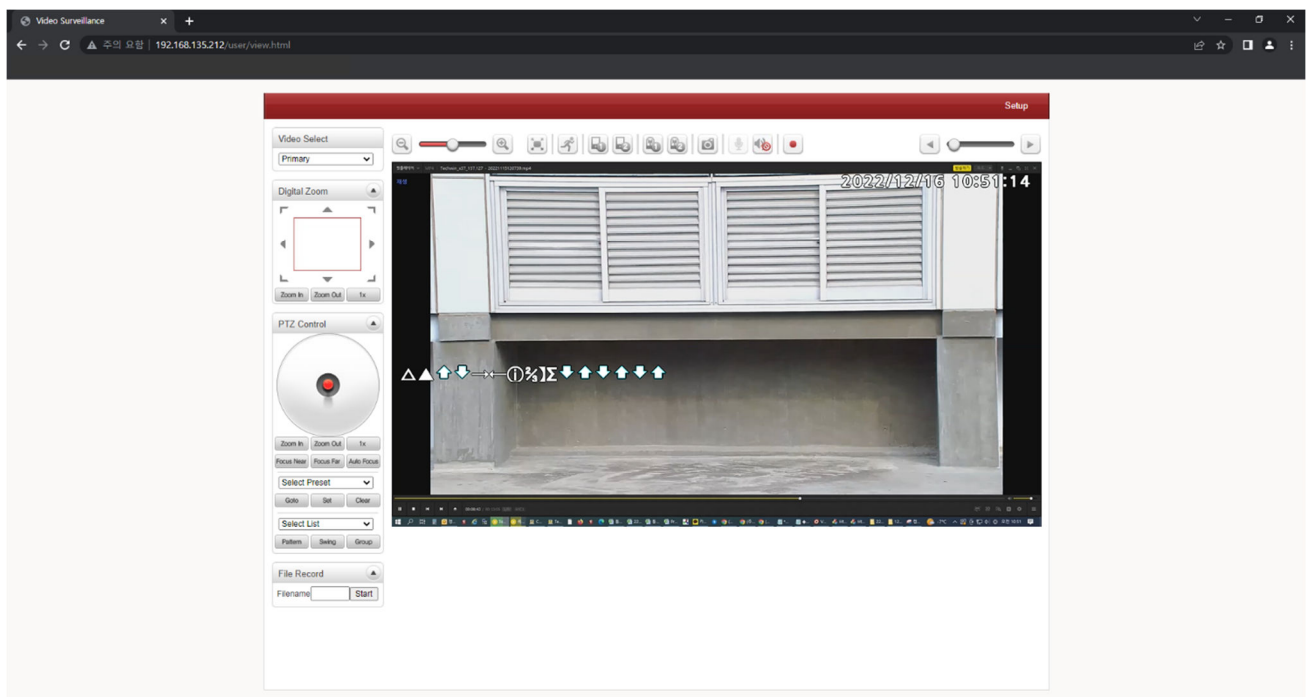

◆ **Video Select**

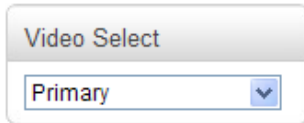

- Select the Video stream to be viewed: Primary, Secondary #1, #2, #3.
- This video server is capable of quadruple streaming; primary streaming and secondary streaming #1~#3.
- Video will be displayed according to the resolution set on video configuration. If dual or quadruple streaming (“Use Dual Encode” Menu in Video page) is not activated, secondary video is not available

◆ **View Size**



- Adjust the size of the screen on the browser. Screen size is initially adjusted according to the resolution of video page

◆ **Digital Zoom**

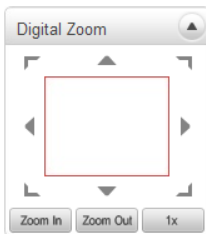

- Control the Digital zoom on the screen. The more the camera zooms in, the smaller the square of control panel is. Position of the image can be changed by moving position of the square. If you press x1, the screen will return to the normal size.

◆ **PTZ Control**



- Control PTZ and PTZ Control Panel is used for controlling external PTZ devices when the external PTZ device is connected through serial port. It is possible to make zooming control by Zoom in/out buttons of PTZ control Panel (In order to use digital zoom, select Digital zoom ON in the Camera tab)
- Focus Near, Focus Far, Auto Focus
Adjust the focus of the lens

◆ **Select Preset**

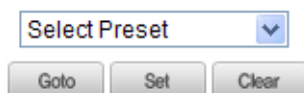

- Set preset position and move to the specific preset position if PTZ Camera is connected to Video Server via Serial Port Set
- Goto
Move to the selected preset entry if the preset entry is set.
- Set
Set the current position to the selected preset entry.
- Clear
Delete the selected preset entry.

◆ **Select List**

- Pattern, Swing, Group can be activated as configured PTZ Page.

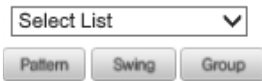

◆ **Sensor Input and Alarm Output**



- Display the status of the sensor in real time. When the sensor of the video server is working, the sensor light turns red and you can operate the alarm device by pressing the number icon. A number icon indicates status of the alarm device.

◆ **Snapshot**



- Capture video images and store them as BMP or JPEG files.

◆ **Talk**



- Transfer audio from PC's mic to the camera

◆ **File Record**

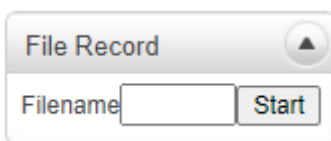

- Recording to an AVI file on Live View page is available. AVI files are generated in the Download folder with a specified file name on the PC where web browser is running.
 1. Enter the file name on a filename field.
 2. Press "**Start**" button to start recording.
 3. Press "**Stop**" button to stop recording.
 4. An AVI file named "**IP address_hh_mm_ss**" or "**File name_IP address_hh_mm_ss**" will be generated in the Download folder.

◆ **Display Buffer**



- Set the number of video frames to be buffered before being displayed on web browser. Larger value results in smoother video by sacrificing the latency. A setting of 10 ~ 15 frames can be used generally for most situations

Initialize of IP Address

If a system IP address is lost, the system can be reset to the system default IP address using the reset button in the back side of the system.

1. While the system is in operation, press the reset button for more than 5 seconds.
2. The system will reboot automatically.
3. Once the system reboots, IP address will be set to the system default as below;

• IP mode	Fixed IP	• IP address	192.168.10.100
• Subnet mask	255.255.255.0	• Gateway	192.168.10.1
• Base port	2222	• HTTP port	80

4. Remote Configuration

Using Web Browser

Remote setting is available by using web browser. Enter the IP address of Video Server and a live view screen will appear as below. Press **Setup** button located in the upper right area of the monitoring screen to go to the server setup. For Remote Setting, user should be authorized higher than manager level.

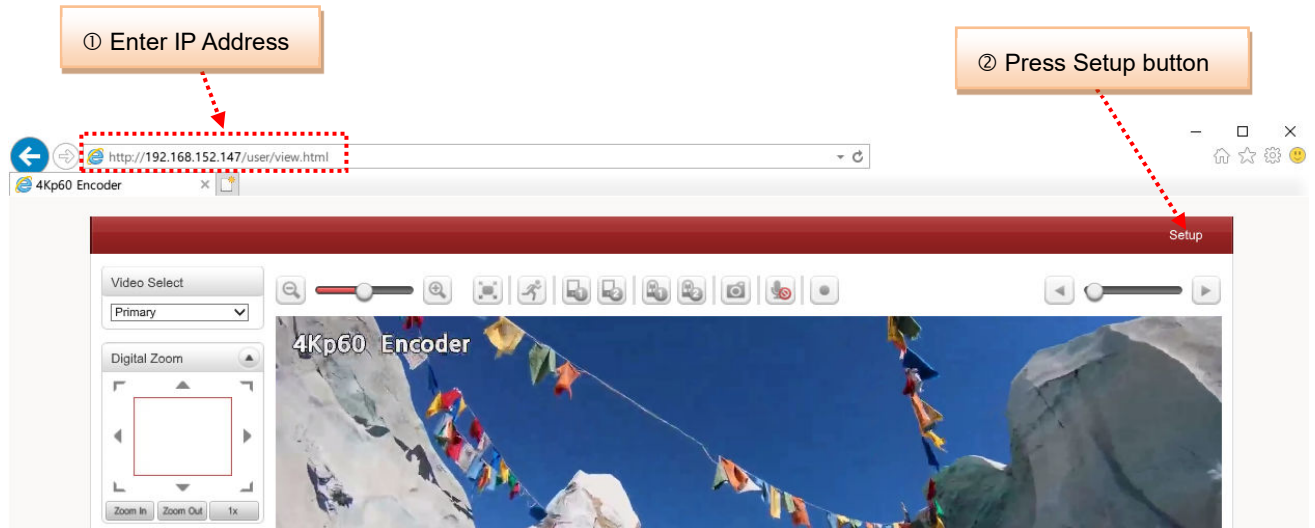

The configurations are grouped into 9 categories: **Video & Audio, Image, Network, Event, Record, Device, PTZ, User, System**. Leaving the page without pressing the **Apply** button, any changes in the page will be discarded.

Video & Audio

Information

The screenshot shows a web interface for configuring video and audio. On the left is a sidebar menu with categories: Video & Audio (expanded), Image, Network, Event, Record, Device, PTZ, User, and System. The 'Video & Audio' section is further divided into Information (selected), Video, Audio, and Output. The main content area displays two tables: 'Video' and 'Audio'. The 'Video' table shows settings for Primary, Secondary#1, #2, and #3 encoding, including Enable status, Algorithm, Resolution, Bitrate, and Framerate. The 'Audio' table shows settings for Audio Encoding and Audio Decoding, including Enable status, Algorithm, Sampling rate, and Bitrate.

Video						
	Enable	Algorithm	Resolution	Bitrate	Framerate	
Primary Encoding	On	H.264	1920x1080	694 (kbps)	30 (fps)	
Secondary#1 Encoding	On	H.264	720x480	1000 (kbps)	30 (fps)	
Secondary#2 Encoding	Off	N/A	N/A	0 (kbps)	0 (fps)	
Secondary#3 Encoding	Off	N/A	N/A	0 (kbps)	0 (fps)	

Audio				
	Enable	Algorithm	Sampling rate	Bitrate
Audio Encoding	On	G.711	8 KHz	66 (kbps)
Audio Decoding	On	-	-	0 (kbps)

- Video and Audio status showed at this page including Algorithm, Resolution, Bitrate etc.

Video

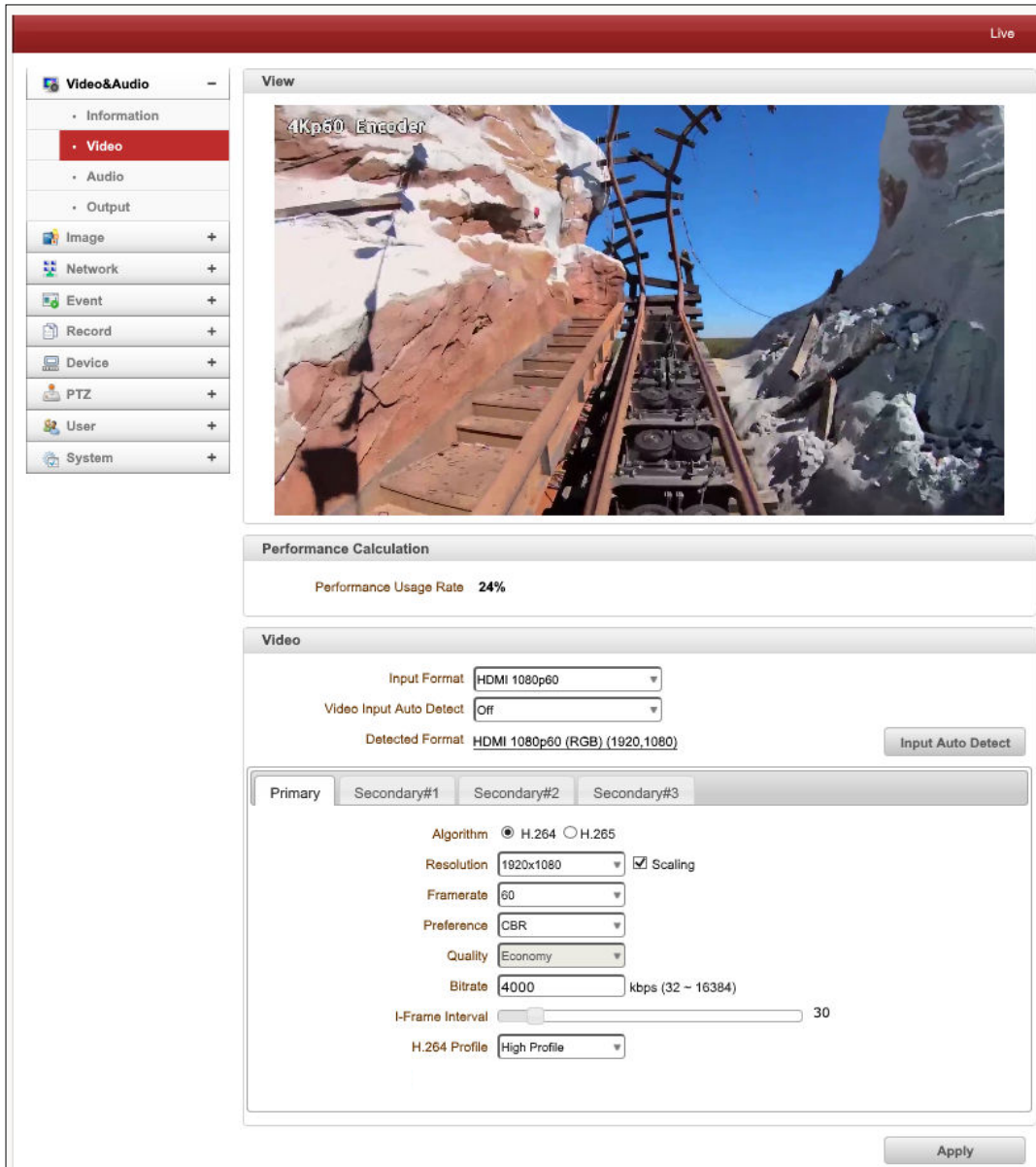

- **Performance Calculation**

This calculation shows the performance usage rate according to the value set

- **Input Format**

Choose the input format from the list that is matched to the output of the camera or other video source.

- **Video Input Auto Detect**

Full Auto provides fixed resolution as input format. When semi auto is enabled, user can select resolution.

- **Detected Format**

Source and video information are shown and whether it is connected to the Encoder

- **Algorithm**

Select compression algorithm. Note that MJPEG is supported only for Secondary streams.

- **Resolution**

Select video encoding resolution.

Scaling option is used when encoding resolution is different from input resolution. Without Scaling option, input video will be cut according to encoding resolution. On the other hand, if Scaling is selected, input video will be adjusted according to the encoding resolution.

- **Framerate**

Determine the maximum number of frames per second for the video stream.

1,2,3,4,5,6,8,10,15,20,25,30 and 60 frame rate can be selected. The actual frame rate of the video can be less than the maximum frame rate set due to the network bandwidth limitation

- **Preference**

Select encoding mode to control video quality or bitrate: Quality(VBR) or Bit rate(CBR and Hybrid). If 'Bitrate' is selected, the video encoding will be affected by the 'Bitrate' value entered. Therefore, "Bitrate" mode corresponds to CBR (Constant Bit Rate) or Hybrid (Hybrid Constant Bit Rate) encoding. If 'Quality' is selected, the video encoded will be affected by the quality of image selected. Therefore, "Quality" mode corresponds to VBR (Variable Bit Rate) encoding.

- **Quality**

Select Video quality. 8 levels of quality are available.

Quality mode (VBR encoding) tries to encode every frame in a constant quality. Therefore, the resulting bitrate may vary a lot depending on the complexity or activity changes in the input video. It is preferred when constant video quality is required and network bandwidth is enough for delivering the stream of highly varying bitrate.

- **Bitrate**

Determine the bitrate value between 32 ~ 16Mbps.

Bitrate mode (CBR encoding) allows you to set a fixed target bitrate that consumes a predictable amount of bandwidth. In order to keep the bitrate limit, video quality is controlled dynamically according to the complexity or activity changes in the input video.

Bitrate mode (Hybrid encoding) allows you to set a maximum bitrate. Bitrate does not exceed the set bitrate but it can decrease automatically when the scene complexity is decreased. This mode allows you to control the bandwidth efficiently.

- **I-Frame Interval**

Determine I-frame Interval between 1 and 255.

- **H.264 Profile**

Select H.264 Profile: **High Profile** or **Baseline Profile**

The standard defines various sets of capabilities which are referred to as profiles that target specific classes of application.

I. High Profile

The Primary profile for broadcast and disc storage applications are used particularly for high-definition television application.

II. Main Profile

This profile is used for standard-definition digital TV broadcasts that use the MPEG-4 format as defined in the DVB standard.

III. Baseline Profile

Primarily used for low-cost applications that require additional data loss robustness, this profile is sometimes used in video conferencing and mobile application. This profile includes all features that are supported in the constrained baseline profile, plus three additional features that can be used for loss robustness.

- **Secondary #1 ~ #3**

The screenshot displays the configuration panel for Secondary video streams. It includes the following settings:

- Enable:** Radio buttons for Off and On (On is selected).
- Algorithm:** Radio buttons for H.264, MJPEG, and H.265 (H.264 is selected).
- Resolution:** Dropdown menu set to 720x480.
- Scaling:** Checkmark box (checked).
- Framerate:** Dropdown menu set to 30.
- Preference:** Dropdown menu set to CBR.
- Quality:** Dropdown menu set to Economy.
- Bitrate:** Input field set to 1024 kbps (range 32 ~ 4096).
- I-Frame Interval:** Slider set to 30.
- H.264 Profile:** Dropdown menu set to High Profile.

- **Use Quadruple Encode**

Select **ON** to enable to use Secondary #1 ~ #3.

The Secondary #1 ~ #3 video can be viewed on **Live View** window by selecting **Stream number** on Video selection

- **Algorithm**

Select H.264, MJPEG or H.265 for the secondary, tertiary or quaternary streaming.

In case of H.264, wither bitrate mode or Quality mode can be selected for Preference mode. On the other hand, MJPEG supports **Quality** mode

- **H.265 Profile**

For a better view of the scene with less buffer, you may select the H.265 profile. Please have in mind that the browsers Chrome, Edge and Mozilla have not yet developed full capability of streaming 100% of H.265 profile. To check the actual H.265 stream, please use a separate video streaming software.

Audio

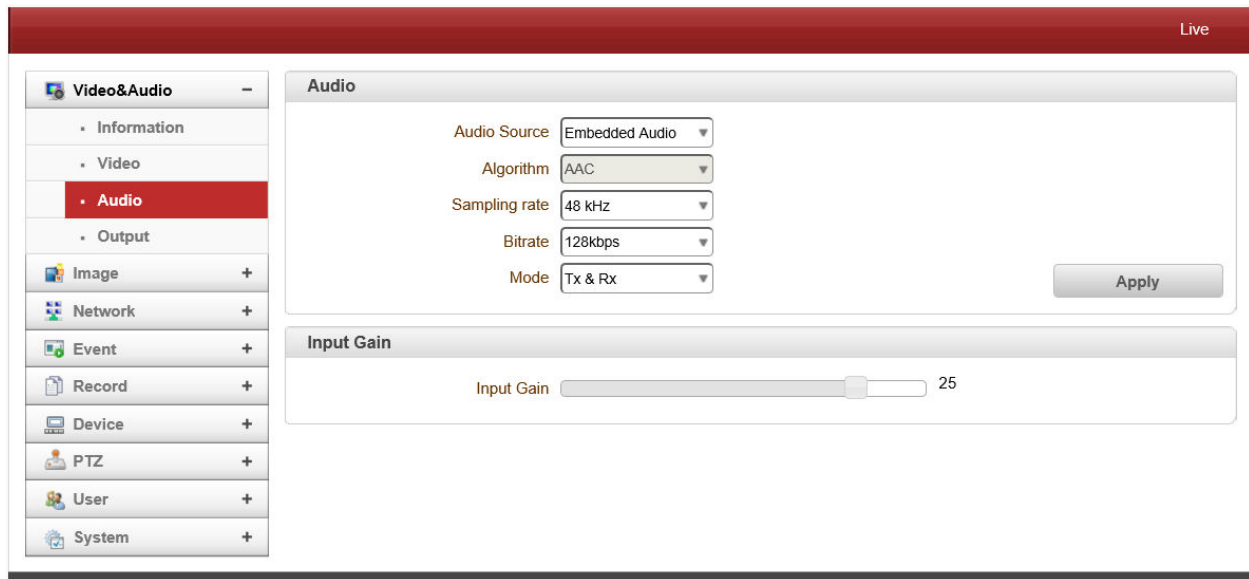

- **Audio Source**

Select the audio source: Embedded or Analog stereo

- **Algorithm**

Select the audio algorithm: G.711 or AAC

G.711 and AAC from client to server direction are supported. Thus, bidirectional audio communication is supported.

- **Sampling rate**

The sampling rate defines the number of samples per unit of time taken from a continuous signal to make a discrete signal.

- **Bitrate**

Select the bitrate between 32Kbps and 192Kbps when AAC is selected

The sampling rate is fixed to 64KHz for G.711 and is 32KHz, 44.1KHz and 48KHz for AAC respectively. Note that when camera is connected to a decoder, the decoder's audio algorithm should be set identically to transmit audio properly.

- **Mode**

Select audio operation mode

Mode	Action
Off	No operation
Tx-Only	Transmit only
Rx-Only	Receive only
Tx & Rx	Transmit and Receive

- **Input Gain**

Set audio input gain from 0 to 31.

Output

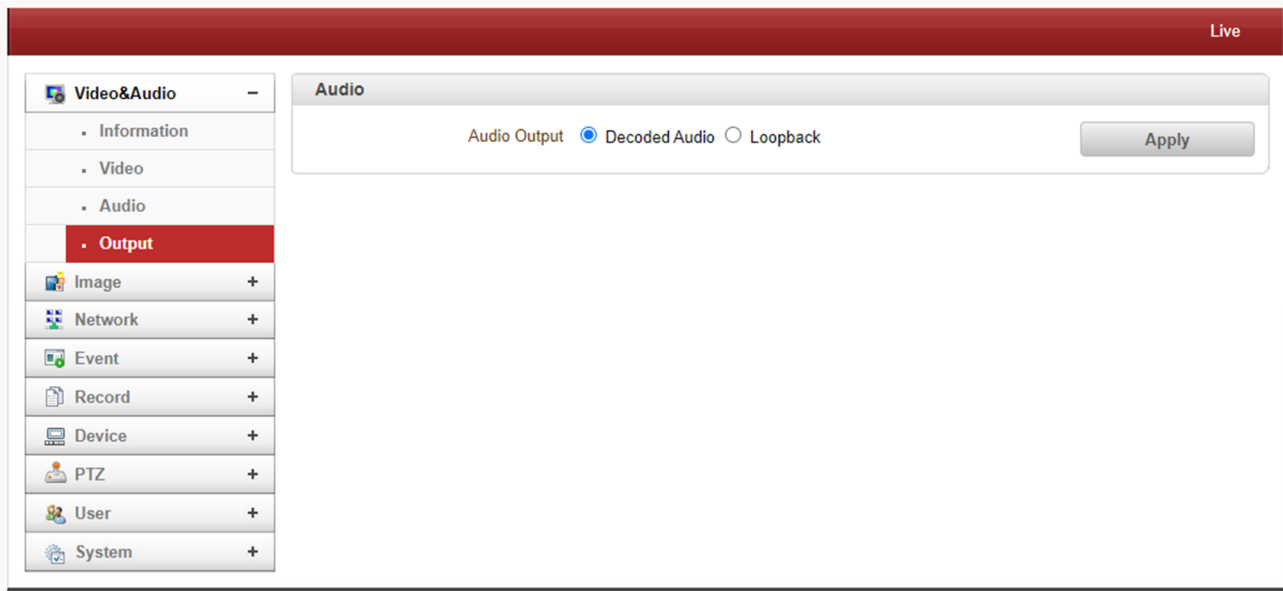

- **Output Format**

Select the format of output when Enable Preview is selected.

- **Audio Output**

Audio Output: The input audio is transmitted to the encoder

Loopback: Does not transmit the audio to the encoder. Audio input and output located at the camera.

Image

General

The screenshot displays the ANTRICA software interface. On the left, a sidebar menu lists various settings categories: Video&Audio (+), Image (-), General (selected), Mask, Network (+), Event (+), Record (+), Device (+), PTZ (+), User (+), and System (+). The main area shows a 'View' window displaying a Windows 10 desktop with a blue background and a taskbar. Below the 'View' window is the 'Codec' configuration panel. It includes three sliders for 'Brightness', 'Contrast', and 'Saturation', each set to a value of 128. A red text warning below these sliders reads: 'Brightness, contrast and saturation are supported only on HDMI'. Below this, there is an 'Edge Enhancement Mode' dropdown menu set to 'On' and an 'Edge Enhancement Strength' slider set to 8. An 'Apply' button is located at the bottom right of the Codec panel.

Brightness

Controls input video brightness by selecting values between 0 and 255.

Contrast

Controls input video contrast by selecting values between 0 and 255.

Saturation

Controls input video saturation by selecting values between 0 and 255

Edge Enhancement

Edge Enhancement is an image processing filter that enhances the edge contrast of an image or video in an attempt to improve its acutance (apparent sharpness)

Mask

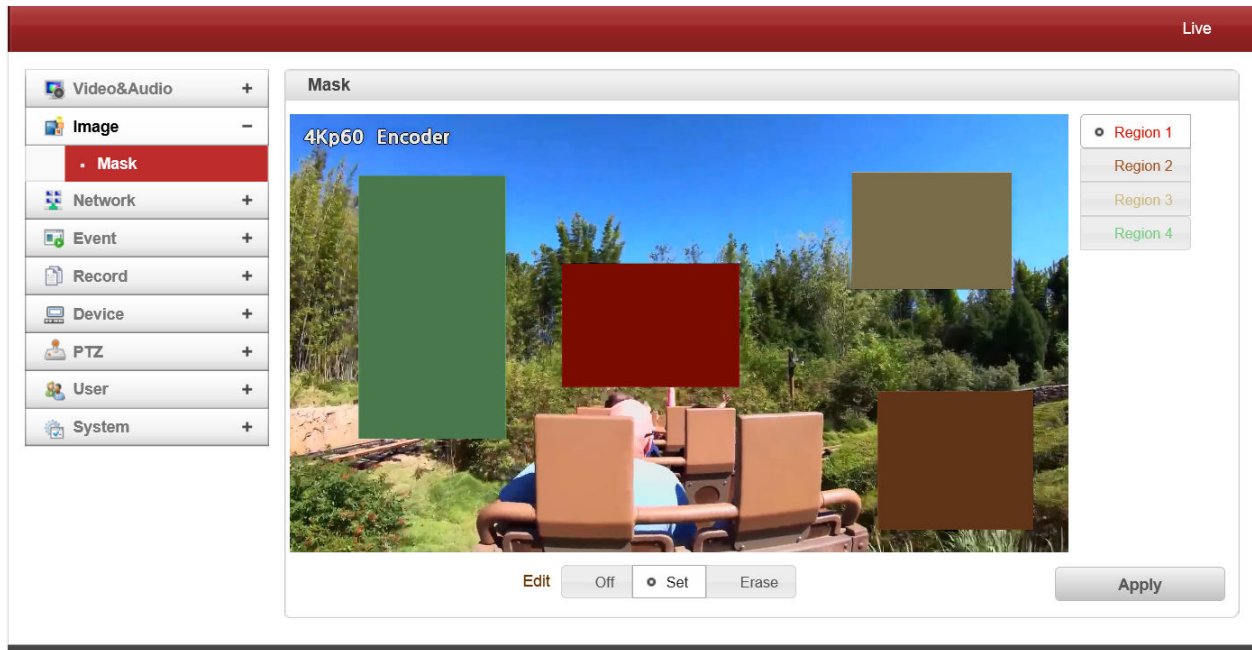

- There are 4 regions that user draw on the video as shown above.

Network

IP & Port

Live

- Video&Audio +
- Image +
- Network -
 - IP&Port**
 - RTSP Multicast
 - QoS
 - Discovery
 - One-way
 - SRT
 - SNMP
 - DDNS
 - IP filtering
 - E-mail
 - FTP
 - Connecting
- Event +
- Record +
- Device +
- PTZ +
- User +
- System +

Local

IP Mode: Fixed IP

Local IP: 192.168.152.147

Local Gateway: 192.168.128.1

Local Subnet: 255.255.192.0

DNS

Obtain DNS server address automatically

Use the following DNS server addresses

Primary DNS Server: 8.8.8.8

Secondary DNS Server: 8.8.8.8

IPv6

IPv6 Address:

IPv6 Subnet Prefix Length: 0

IPv6 Default Gateway:

IPv6 LinkLocal: fe80::21c:63ff:feaa:92f/64

Port

Base Port: 2222 (1025~65535)

HTTP Port: 80 (80, 1025~65535)

HTTPS Port: 443 (443, 1025~65535)

RTSP Port: 554 (554, 1025~65535)

Audio Receive Port: 2280 (1025~65535)

MTU Size

MTU Size: 1500 (default:1500, 68~)

Multicast

Multicast IP: 224.10.0.0 (224.0.0.0 ~ 239.255.255.255)

TTL: 64 (1~255)

- **Local**

Select the IP mode: Fixed IP or DHCP

Depending on the selected mode, further configuration items come as follows,

IP Mode	Selection	Description
Fixed IP	Local IP	Fixed IP address
	LocalGateway	Gateway IP address
	Local Subnet	Subnet mask
DHCP	N/A	

Please ask IP address information from ISP provider or network manager.

- **DNS**

➤ **Obtain DNS server address automatically**

Get DNS server address automatically when IP mode is DHCP.

➤ **Use the following DNS server address**

Enter the DNS server IP address; Primary or Secondary DNS server

Domain Name System (DNS) is a database system that translates a computer's fully qualified domain name into an IP address. Networked computers use IP addresses to locate and connect to each other, but IP addresses can be difficult for people to remember. For example, on the web, it's much easier to remember the domain name `www.amazon.com` than it is to remember its corresponding IP address (`207.171.166.48`). Each organization that maintains a computer network will have at least one server handling DNS queries. That server, called a name server, will hold a list of all the IP addresses within its network, plus a cache of IP addresses for recently accessed computers outside the network.

- **IPv6**

➤ **Ipv6 Address:** Enter the designated Ipv6 address.

➤ **Ipv6 Subnet Prefix Length:** Enter the bit number of Ipv6 Subnet

➤ **Ipv6 Default Gateway:** Enter the designated Ipv6 gateway.

➤ **Ipv6 Link Local:** Display Ipv6 Link Local.

- **Port**

➤ **Base Port (1025~65535)**

Enter the Base Port number

Network base port is used for communication with remote clients. In order for camera and remote systems to be connected, the port number must be identically configured in camera side and client side.

➤ **HTTP Port (80, 1025~65535)**

Enter HTTP port used for web-based connection.

- **HTTPS Port (443, 1025~65535)**
Enter HTTPS port used secured HTTP connection.
- **RTSP Port (554, 1025~65535)**
Enter RTSP port used for RTSP-based connection. The default TRSP port is 554.
RTSP (Real Time Streaming Protocol) is a standard for media streaming between server and client.
- **Audio Receive Port**
Enter Audio port used for audio transmission from client or other software. Default Audio Receive Port is 2280.
- **MTU Size**
MTU (Maximum Transmit Unit) is the size of the largest protocol data unit that can be communicated in a single network layer transaction. Default value is 1500.
- **Multicast**
The Multicast menu is used for configuring the multicast IP address to which media stream is delivered when a client such as a Decoder, VMS or NVR software is connected in multicast mode. The multicast IP address selection range is between 224.0.0.0 and 239.255.255.255. The selection can be used only when media protocol is set to Multicast.

RTSP Multicast

RTSP Multicast used to specify the multicast address to be used when the client requests RTSP multicast via ONVIF command.

	Multicast IP	Port
Primary	224.10.0.0	64704
Secondary #1	224.10.0.0	64706
Secondary #2	224.10.0.0	64722
Secondary #3	224.10.0.0	64724
Audio	224.10.0.0	64802
Metadata	224.10.0.0	64902

Apply

QoS

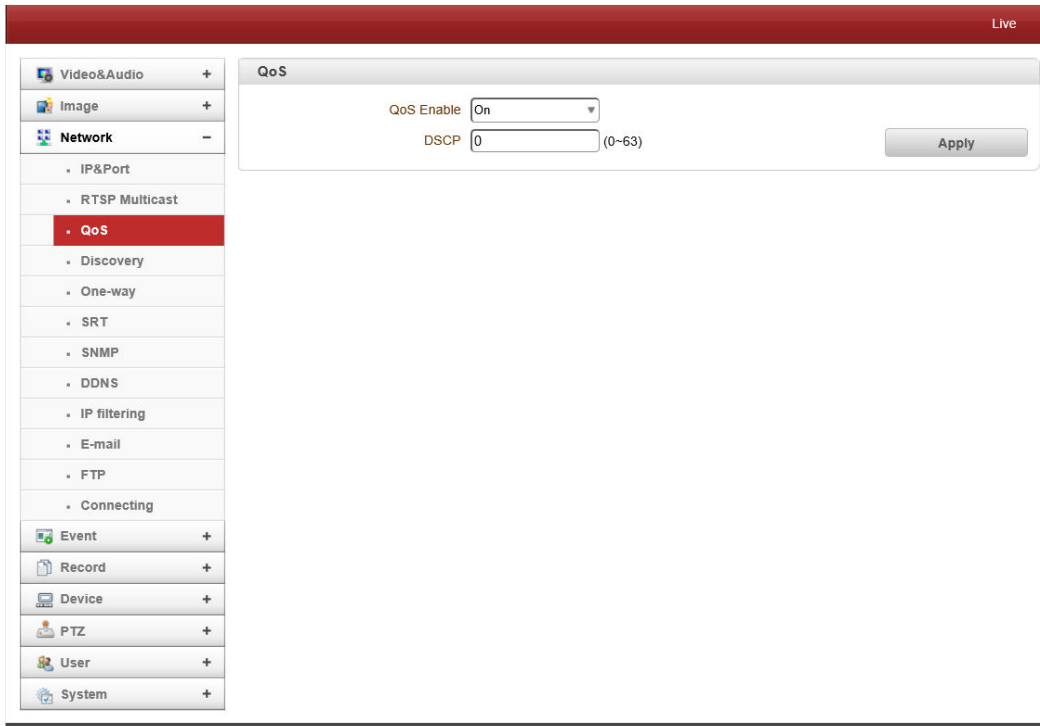

- QoS (Quality of Service) guarantees a certain level of a specified resource to selected traffic on a network. A QoS-aware network prioritizes network traffic and provides greater network reliability by controlling the amount of bandwidth and application may use. Using DSCP (Differentiated Services Codepoint) values, Video Server can mark the following types of traffic: live video, event/alarm traffic and management traffic.

Discovery

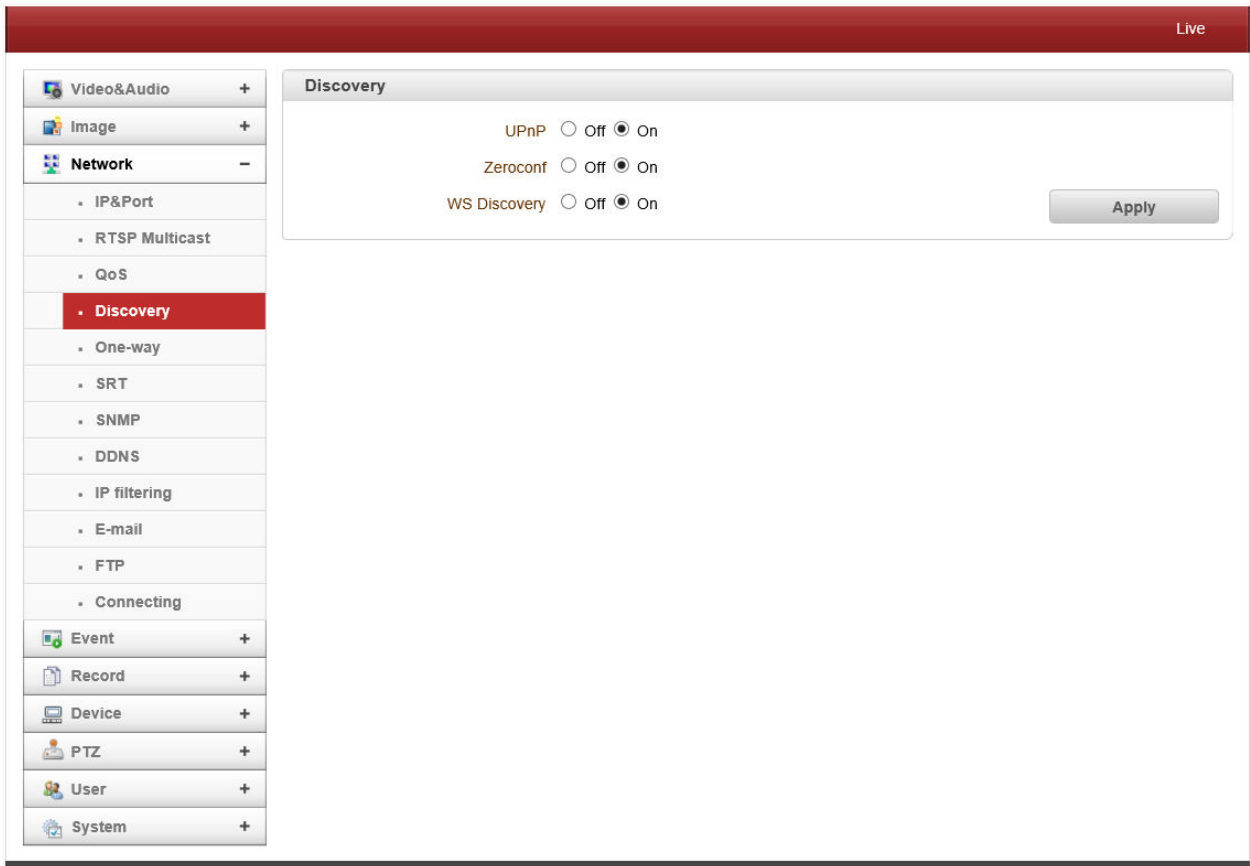

Live

Video&Audio +
Image +
Network -
 . IP&Port
 . RTSP Multicast
 . QoS
 . **Discovery**
 . One-way
 . SRT
 . SNMP
 . DDNS
 . IP filtering
 . E-mail
 . FTP
 . Connecting
Event +
Record +
Device +
PTZ +
User +
System +

Discovery

UPnP Off On
Zeroconf Off On
WS Discovery Off On

Apply

- **UPNP**
By the setting **UPNP** to ON, it allows the discovery by the client according to UPNP (Universal Plug and Play) protocol.
- **Zeroconf**
By setting **Zeroconf** to ON, it allows the discovery by the client according to zeroconf protocol.
- **WS Discovery**
Discovery function based on web service is enabled. It allows the discovery by the client SW which is supporting Onvif.

One-way

The screenshot displays the ANTRICA web interface. On the left, a navigation menu lists various settings categories: Video&Audio, Image, Network, Event, Record, Device, PTZ, User, and System. The 'Network' category is expanded, and the 'One-way' option is highlighted in red. The main content area is titled 'One-way Streaming' and features a 'Mode' dropdown menu currently set to 'Off'. An 'Apply' button is located at the bottom right of the configuration area.

- Video Server provides two kinds of one-way (unidirectional) streaming based on UTP to clients; **MPEG-TS and RTMP**. Both are a kind of broadcasting where traffic from clients to a server is not generated at all.
- **MPEG-TS** is a standard format for transmission and storage of audio, video, and data, and is used in broadcast systems such as DVB and ATSC. Transport Stream is specified in MPEG-2 Part 1, Systems (formally known as ISO/IEC standard 13818-1 or ITU-T Rec. H.222.0). Transport stream specifies a container format encapsulating packetized elementary streams, with error correction and stream synchronization features for maintaining transmission integrity when the signal is degraded. As MPEG-TS itself supports only AAC as the audio algorithm, only video is streamed when audio algorithm is set to G.711.
- **Related settings are as follows:**
 - **Destination IP** : Set the IP Address of the destination system which will receive MPEG-TS stream.
 - **Destination Port** : Set the Port of the Destination system which will receive MPEG-TS stream.

- **RTMP (Real-Time Messaging Protocol)** is for streaming audio, video and data over internet between a Flash player and a server. (H.265 RTMP streaming is not supported)
- **Destination IP** : Set the IP Address of the destination system which will receive RTMP Stream.
- **StreamName** : Enter the streamname that will be used as session name
- **User Name** : Enter the user name that will be used as session name
- **Password** : Enter the password that will be used as session name

SRT (Secure Reliable Transport).

- SRT is an open source project which is Video and Audio transmission protocol developed by SRT Alliance. SRT optimizes streaming performance across unpredictable networks, such as the Internet, by dynamically adapting to the real-time network conditions between transport endpoints.

- **Listener** : The SRT stream acts like a server (Decoder) and listens & waits for clients to connect to it.
- **Caller** : The SRT stream acts like a client and connects to a server listening and waiting for an incoming call.
- **Destination Port** : Specifies the UDP destination port for the SRT stream.
- **Secure** : Enables AES encryption and specifies the key length, either: None, AES-128, or AES-256

SNMP

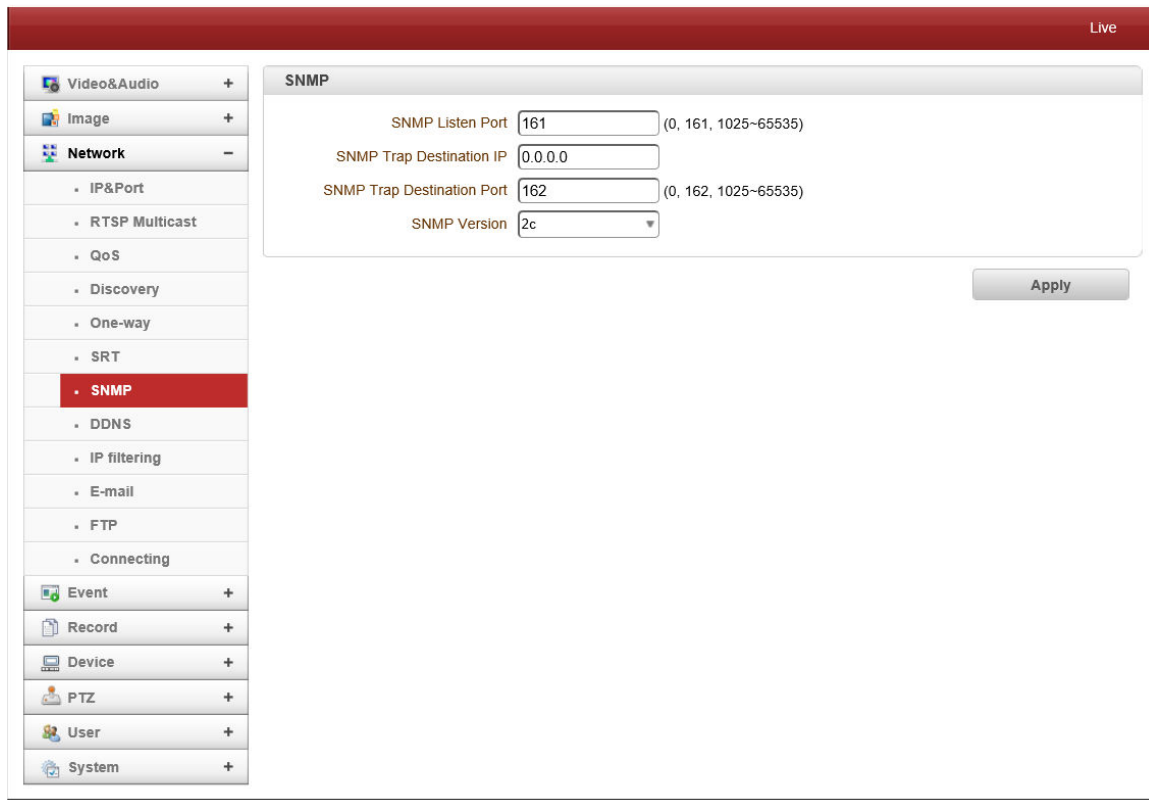

This Setup is used for SNMP (Simple Network Management Protocol). It is compatible to both SNMPv1 and SNMPv2c. Settings for using SNMP are as following;

- **SNMP Listen Port (0, 161, 1025 ~ 65535)**
The port is for connecting external device when system operates as a SNMP client. SNMP is not used by setting 0 value.
- **SNMP Trap Destination IP**
Set the SNMP Trap Destination IP.
- **SNMP Trap Destination Port (0, 162, 1025 ~ 65535)**
Set the SNMP Trap Destination Port. SNMP is not used by setting 0 value.

Simple Network Management Protocol (SNMP) is used by network management systems to communicate with network elements. SNMP lets TCP/IP-based network management clients use a TCP/IP-based internetwork to exchange information about the configuration and status of nodes. SNMP can also generate trap messages used to report significant TCP/IP events asynchronously to interested clients. For example, a router could send a message if one of its redundant power supplies fails or a printer could send an SNMP trap when it is out of paper

- **SNMP Version**
Select SNMP Version 1, 2C or 3

DDNS

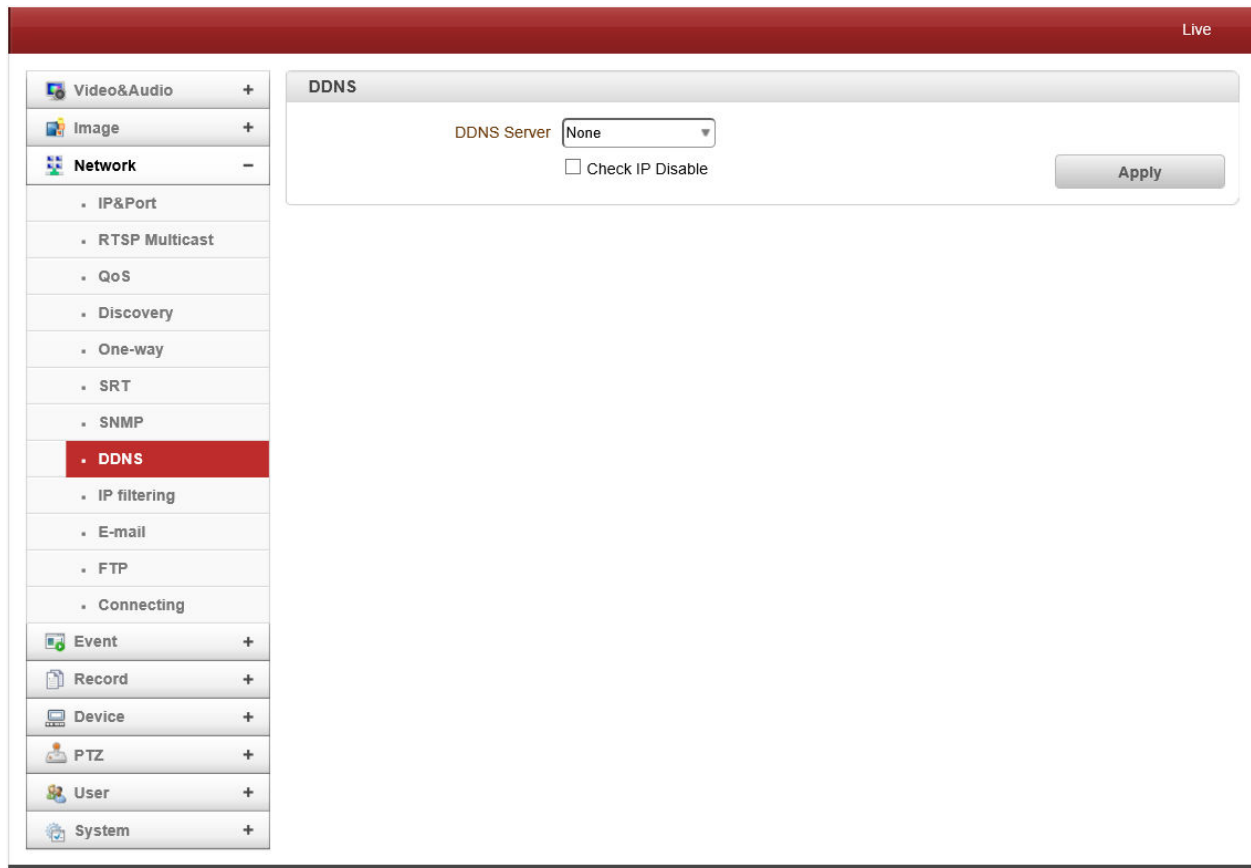

Select DDNS (Dynamic DNS) server to use. One of the two can be selected.

- **TrueDNS**

True DNS service is used in the mode. Systems can be registered on the website for True DNS service, <http://ns1.truecam.net>. A system will get a domain name of xxx.truecam.net. Please refer to user guide document for True DNS service.

- **DynDNS**

Dyn DNS service is used in this mode. Refer to www.dyndns.org for details. ID, Password and Domain name are needed when DYN DNS is set.

Dynamic DNS is a method, protocol, or network service that provides the capability for a networked device, such as a router or computer system using the Internet Protocol Suite, to notify a domain name server to change, in real time (ad-hoc) the active DNS configuration of its configured hostnames, addresses or other information stored in DNS.

- **Vdyn**

Vdyn is a DDNS service provided by Visionica (<http://visionica.com>). No further configuration is required for using this service. It internally uses MAC address for the registration. When it succeeds, the domain name of the form 001C63A607EC.visionica.info is displayed on Current Domain entry of Network page. E-mail setting is not mandatory.

- **Check IP Disable**

If “Check IP Disable” is selected, it will skip to check its own IP. In fixed IP mode, the set IP will be registered on DDNS server. In DHCP mode, dynamically assigned IP will be registered on DDNS server. Normally **Check IP Disable** should be unchecked in order to obtain public IP in the network.

IP filtering

Live

Video&Audio +
Image +
Network -
 • IP&Port
 • RTSP Multicast
 • QoS
 • Discovery
 • One-way
 • SRT
 • SNMP
 • DDNS
 • **IP filtering**
 • E-mail
 • FTP
 • Connecting
Event +
Record +
Device +
PTZ +
User +
System +

IP Filtering

Basic Policy Allow all

Access from IPs in the following list will not be allowed.

No.	From	To	Enable
1	0.0.0.0	0.0.0.0	<input type="checkbox"/>
2	0.0.0.0	0.0.0.0	<input type="checkbox"/>
3	0.0.0.0	0.0.0.0	<input type="checkbox"/>
4	0.0.0.0	0.0.0.0	<input type="checkbox"/>
5	0.0.0.0	0.0.0.0	<input type="checkbox"/>
6	0.0.0.0	0.0.0.0	<input type="checkbox"/>
7	0.0.0.0	0.0.0.0	<input type="checkbox"/>
8	0.0.0.0	0.0.0.0	<input type="checkbox"/>
9	0.0.0.0	0.0.0.0	<input type="checkbox"/>
10	0.0.0.0	0.0.0.0	<input type="checkbox"/>
11	0.0.0.0	0.0.0.0	<input type="checkbox"/>
12	0.0.0.0	0.0.0.0	<input type="checkbox"/>
13	0.0.0.0	0.0.0.0	<input type="checkbox"/>
14	0.0.0.0	0.0.0.0	<input type="checkbox"/>
15	0.0.0.0	0.0.0.0	<input type="checkbox"/>
16	0.0.0.0	0.0.0.0	<input type="checkbox"/>
17	0.0.0.0	0.0.0.0	<input type="checkbox"/>
18	0.0.0.0	0.0.0.0	<input type="checkbox"/>
19	0.0.0.0	0.0.0.0	<input type="checkbox"/>
20	0.0.0.0	0.0.0.0	<input type="checkbox"/>

Apply

- IP filtering is simply a mechanism that decides which types of IP datagrams will be processed normally and which will be discarded.

E-mail

E-mail Specify the information to send event information, when E-mail is selected as an event action.

- **Server Address**
Enter an address of mail (SMTP) server
- **Port**
Specify a port for SMTP operation (**Port 25 is the default port in SMTP operation.** If a different port is configured in the SMTP server, this ports needs to be changed accordingly.)
- **Sender Address**
Enter an account registered in SMTP server.
- **Authentication on SMTP server**
This function is applicable when the E-mail server requires authentication for sending E-mail.
- **ID & Password**
When the server requires authentication, ID and Password of an E-mail account need to be entered.
- **Destination Address**
Enter Destination address. More than one address can be entered by delimiting comma (,) or semi-colon (;). Destination address can take up to 63 characters.

➤ **E-mail Test**

E-mail sending can be tested with this button. Please note that configured settings should be saved first by pressing **Apply** button before using E-mail Test function. One of the following messages will come as a result of the test.

Message↕	Description↕
E-mail sent successfully↕	Test E-mail has been sent successfully. Reception in the client can be checked.↕
Failed to connect SMTP server↕	Connection to the SMTP server failed. It is necessary to check if the server is reachable and server address and port are correct.↕
Authentication failed↕	The server is reachable but authentication failed. ID and/or password need to be checked.↕
SMTP server rejected the mail↕	The server is reachable, but mail sending failed due to a reason other than authentication. This error happens often when the server authenticates according to its own rule. For example, IP addresses of a specific range or addressed of a specific suffix are allowed.↕

- **E-mail Notification**

➤ **Video Clip Attaching**

Video clip stored at the moment of event can be attached as an AVI or JPEG file format. When dual or quadruple encoding is enabled, **Primary video**, **Secondary video** (H.264 only) or **JPEG Capture** can be selected.

The number of JPEG frames is configured. This setting is applicable only when **JPEG Capture** is selected.

➤ **Capture Interval**

Select the interval of captured frame.

FTP

- Specify the information to upload event information, when FTP is selected as an event action.

- **FTP**

- **Server Address**

Enter an address of an RTP server to receive video files

- **Port**

Specify a port for FTP operation (port 21 is the default port in FTP operation. If a different port is configured in the FTP server, this port needs to be changed accordingly.)

- **ID & Password**

Enter ID and password for accessing the FTP server.

- **FTP file name**

The names of files upload by FTP can be specified by the user. If a fixed name is specified, the file is overwritten repeatedly.

Max length of a file name is 60 characters. If the name is left blank, file name is determined according to the internal rule implemented in the firmware.

The following macros are supported to form variable parts of file names. The strings are case-sensitive.

%YYYY : year

%MM : month
 %DD : day
 %hh : hour
 %mm : minute
 %ss : second
 %EVENT : event type (Sensor1, Motion, ...)
 %ADDR : address of the server (Domain name when DDNS is used. Otherwise IP address)
 “.avi” or “.jpg” will be added automatically at the end of the filename depending on the type of video file.

➤ **FTP Base Directory**

Specify the name of the directory to be created in the FTP server. It is valid only when Use Record is set to Use on Record session.

➤ **FTP Test**

FTP upload function can be tested with this button. Please note that configuration settings should be saved first by pressing **Apply** button before using FTP test function. One of the following messages will appear as a result of the test.

Message [↗]	Description [↗]
FTP connection tested successfully [↗]	The connection to the FTP server is successful. [↗]
Failed to connect FTP server [↗]	The connection to the FTP server failed. It is necessary to check if the server is reachable and server address and port are correct. [↗]
Authentication failed [↗]	The server is reachable but authentication failed. ID and/or password need to be checked. [↗]
Failed to upload file [↗]	File upload failed. The user of the ID is not allowed for writing into the directory or FTP server can be full. [↗]
Failed to erase file [↗]	Failed to delete the test file. The user of the ID doesn't have the privilege for file deletion. [↗]

- **FTP Upload**

➤ **Upload Video**

Primary video and secondary, tertiary or quaternary video (H.264 only), JPEG capture can be selected for uploading.

➤ **Number of Frame**

Enter frame number of JPEG capture. (1 ~ 10)

➤ **Capture Interval**

Select the interval of captured frame.

- **Continuous Upload**
Continuous upload 'ON' allows video clips to be transmitted regularly regardless of occurrence of event. When this mode is activated, FTP upload by event is suppressed.
- **Upload Duration**
Specify recording duration of a video clip to be transmitted. (max 300 sec.)
- **Upload Interval**
Specify transmission interval. (max 3600 sec.)
Upload duration is not included in upload interval. For example, if upload interval is 60 sec. and upload duration is 20 sec, a video clip for 20 sec is transmitted every 80 sec.

Connecting

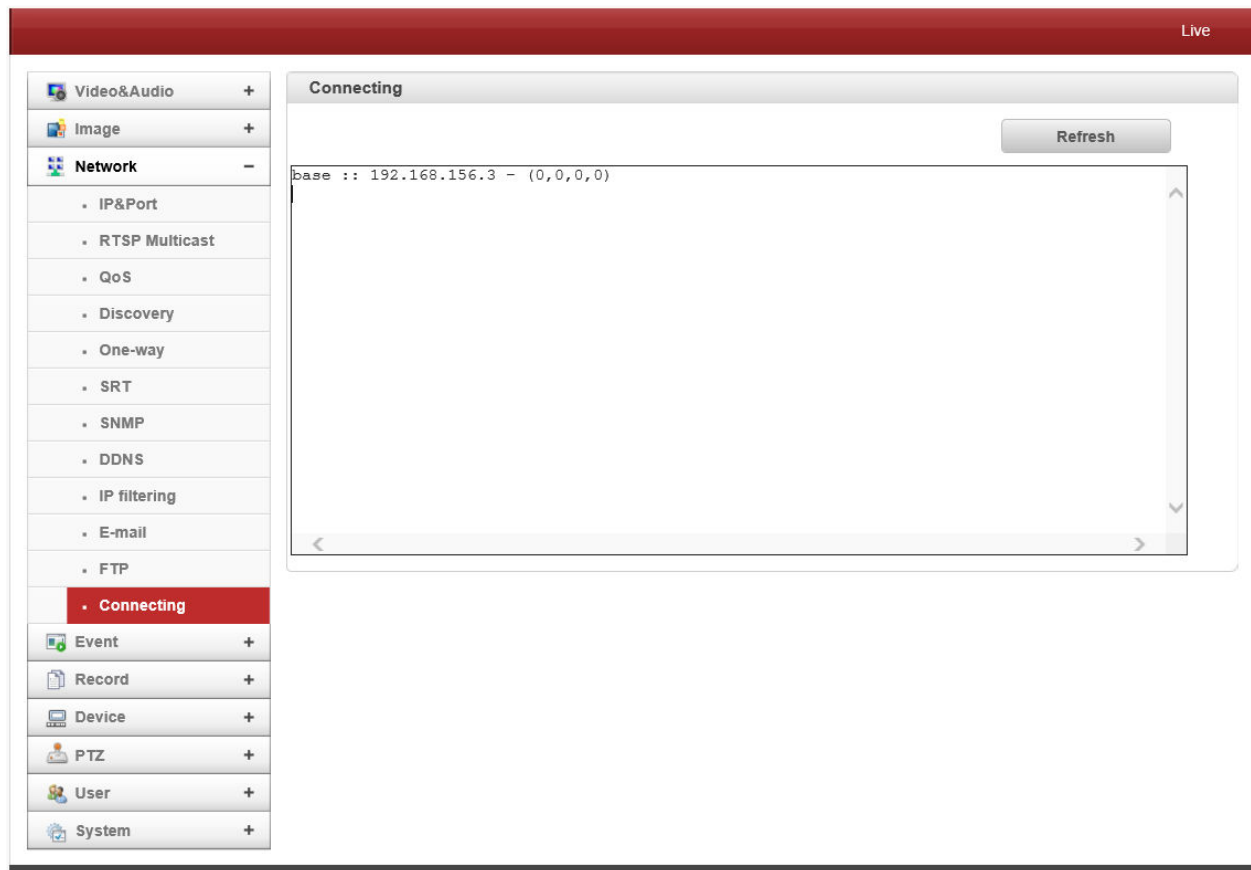

- Client IP Addresses that are currently connected to the system are listed.

Event Notification

The screenshot shows a web-based configuration interface for event notifications. On the left is a sidebar menu with categories like Video&Audio, Image, Network, Event, Record, Device, PTZ, User, and System. The main area is titled 'Event Notification' and is divided into four sections: Local, Remote, On Disconnect, and User Defined Event. Each section contains a table of actions and their settings. The 'Local' section has rows for Sensor 1, Sensor 2, On Video Loss, On Motion, and Audio Detection. The 'Remote' section has rows for Sensor 1, Sensor 2, Sensor 3, and Sensor 4. The 'On Disconnect' section has one row. The 'User Defined Event' section has rows for User Defined 1, User Defined 2, User Defined 3, and User Defined 4. Each row contains columns for Beep, Alarm1, Alarm2, E-mail, FTP, Preset, No Preset, Event OSD Off, and Http Action Off. An 'Apply' button is located at the bottom right of the configuration area.

- Local

When a decoder instead of a PC client is connected to an IP camera, one system becomes a Local system and the other a Remote system (Generally a system which is being used by the user is called a Local system). Then, actions for events can be configured for events from the remote system as well as for local system. For example, it is possible to turn on an alarm device in local (center) decoder system when a sensor device in remote (site) IP camera is triggered. **Local** section configures the actions for events from local (self) system, and configuration activates local devices and **Remote** sections configure the actions for events from remote (peer) system.

The following table lists the possible actions for events.

Action	Description
Beep	Triggers beep port.
Alarm out	Triggers alarm (relay) port.
E-mail	Sends E-mail to the specified address. AVI file can be attached
FTP	Upload AVI file to a specified FTP server
Preset	Move to the Preset position
Event OSD	Display OSD
Http Action	Transmit HTTP API

- **Sensor1 / Sensor2**

Configure the actions when the sensor is activated. Multiple actions can be set for a single event.

- **On Video Loss**

Configure the actions when video input signal is lost. Multiple actions can be set for a single event.

- **On Motion**

Configure the actions when motion is detected. Multiple actions can be set for a single event.

- **On Disconnect**

Configure the actions when the link (connection) with peer system is disconnected. Multiple actions can be set for a single event. This event happens when the last client which has been receiving video from the camera loses the connection.

User Defined Event

The screenshot displays the 'User Defined Event' configuration page. On the left is a sidebar menu with various system settings. The 'Event' category is expanded, showing sub-items like 'Notification', 'User Defined Event', 'Motion Detection', 'Audio Detection', 'Sensor', 'Alarm', 'Event OSD', and 'HTTP Action'. The 'User Defined Event' sub-item is selected and highlighted in red. The main content area shows a table with four rows for 'User Defined 1' through 'User Defined 4', each with a dropdown menu currently set to 'None'. An 'Apply' button is positioned at the bottom right of this configuration area.

- User can define events up to 4.

Motion Detection

The screenshot displays the ANTRICA web interface for Motion Detection configuration. On the left is a sidebar menu with categories: Video&Audio, Image, Network, Event (expanded to show Notification, User Defined Event, Motion Detection, Audio Detection, Sensor, Alarm, Event OSD, HTTP Action), Record, Device, PTZ, User, and System. The main panel is titled 'Motion Detection' and features a 'Use Motion Detection' toggle set to 'Region-based'. Below this is a video feed with a red motion detection region overlaid. To the right of the video are eight sensitivity sliders for Region 1 through Region 8, all set to 5. Below the video are 'Edit', 'Off', 'Set', and 'Erase' buttons, and an 'Apply' button. The 'Motion Schedule' section below has a 'Select' toggle set to 'Motion Enable' and a calendar grid for days of the week (SUN to SAT) and hours (0 to 23). An 'Apply' button is at the bottom right of the schedule section.

- Use Motion Detection

Determine to use **Motion Detection** function.

- Motion Detection Area Editing

Configure region for motion detection. Regions of arbitrary shape can be configured by the following steps;

- I. Select **Enable** on **Edit** tab.
- II. Select editing mode. **Set** is for including cells to motion detection region and **Erase** is for excluding.
- III. Select cells by right clicking. Multiple cells can be selected by pressing and dragging.
- IV. Press **Apply** **Edit Area** to save the setting.

Audio Detection

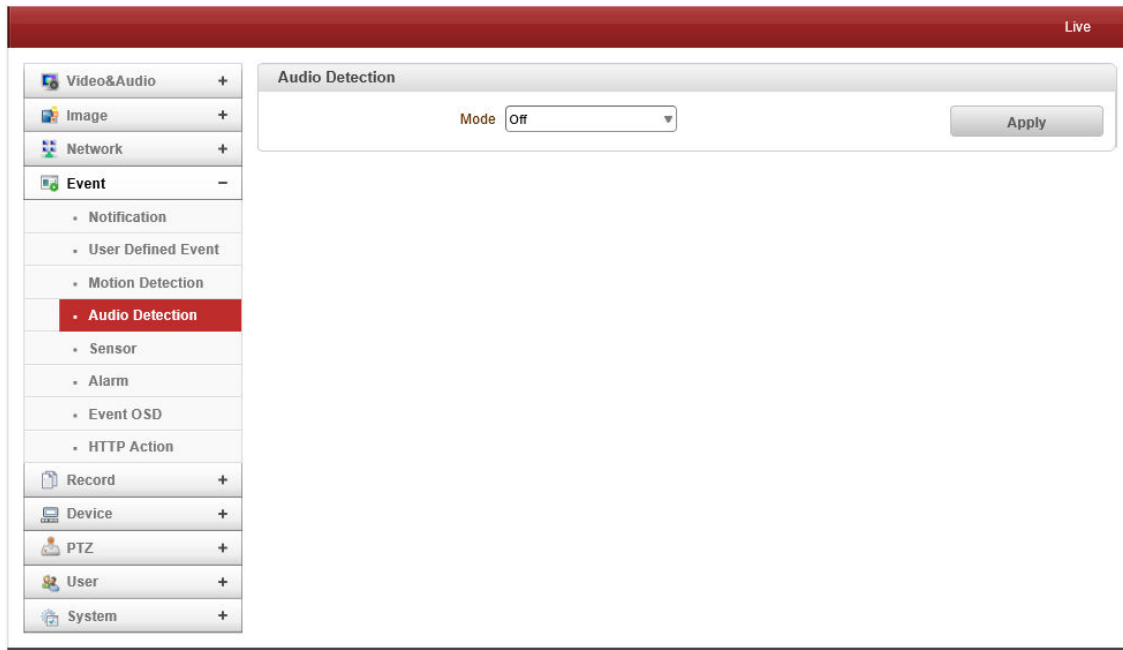

Silence Detection

When silence is detected for a specified amount of time, it will work with event. Detection level is between -10dBFS and -60 dBFS and time can be set up to 120 seconds.

- **Sound Detection**

When sound is detected for a specified amount of time, it will work with event. Detection level is between -10dBFS and -60 dBFS and time can be set up to 120 seconds.

Sensor

Live

- Video&Audio +
- Image +
- Network +
- Event -
 - Notification
 - User Defined Event
 - Motion Detection
 - Audio Detection
 - Sensor
 - Alarm
 - Event OSD
 - HTTP Action
- Record +
- Device +
- PTZ +
- User +
- System +

Sensor Type

Sensor 1 Off N/O N/C

Sensor 2 Off N/O N/C

Sensor Schedule

Select Sensor Off Sensor On

Sensor 1

	0	1	2	3	4	5	6	7	8	9	10	11	12	13	14	15	16	17	18	19	20	21	22	23	
SUN																									
MON																									
TUE																									
WED																									
THU																									
FRI																									
SAT																									

Sensor 2

	0	1	2	3	4	5	6	7	8	9	10	11	12	13	14	15	16	17	18	19	20	21	22	23	
SUN																									
MON																									
TUE																									
WED																									
THU																									
FRI																									
SAT																									

- Sensor Type

There are two sensor input ports on the video server. Each of the sensor ports can be configured to the followings;

Function	Operation
OFF	Not used
NO (Normally Open)	The port is normally open and activated when closed.
NC (Normally Closed)	The port is normally closed and activated when opened.

The function of the sensor port is set based on the type of the sensor connected.

- Sensor Schedule

Choose **Sensor OFF** or **Sensor On** and click the below schedule table to make a sensor schedule according to day of week and hours.

46/73

Alarm

- Set the duration of alarm or beep activation in case of an event. If it is set to **continuous**, it will be in active state until the operator resets it manually.

Event OSD

No.	Display Event Type	String	X-Coord (0-1000)	Y-Coord (0-1000)	Font Size (12-84)	Color
1.	<input type="checkbox"/>		0	0	30	White
2.	<input type="checkbox"/>		0	0	30	White
3.	<input type="checkbox"/>		0	0	30	White
4.	<input type="checkbox"/>		0	0	30	White

- User can create OSD in any position with above options with different colors.
-

HTTP Action

No.	String	Enable
1.	<input type="text"/>	<input type="checkbox"/>
2.	<input type="text"/>	<input type="checkbox"/>
3.	<input type="text"/>	<input type="checkbox"/>
4.	<input type="text"/>	<input type="checkbox"/>

According to Event, Video Server will transmit HTTP API to Device. (User should put in HTTP API)
Before starting this feature, please enable HTTP Action on Notification page

Record

General

Use record

- Off : Recording function will not be used when “OFF” is selected.
- Use Disk : Use disk function will follow the setting of Schedule table which set as record off as a default.

- **Select Video**
Select video stream to record.
- **Manual record**
When On is selected, record is operated regardless of schedule.
- **Overwrite**
When the disk becomes full, the oldest data are deleted automatically. It is valid only when Use Record is set to Use disk.
- **Max File Size / Max File Length**
Max File Size option is for limiting the size of AVI file. If small file size is set, files of small size will be generated but numbers of the files will be increased. Max File Length option is for limiting the time length of AVI file. If the size of a file becomes Max File Size or the duration of the recording reaches Max File Length, a new file is created.
- **Record File Format**
Select file format, AVI or MP4.
- **Automatically Backup to FTP**
Data recorded in the disk can be uploaded to an FTP server automatically for backup. FTP server is configured on the Event page. It is valid only when Use Record is set to Use Disk.

Checking status of recording

- Recording status can be checked on the main view page.

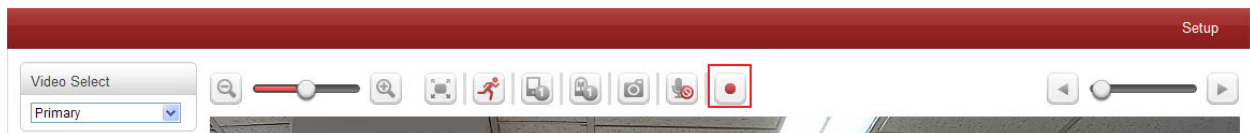

Schedule

- Event Type

Three recording modes are supported: Continuous, Event, Disconnect. In case of Event recording, event types can be selected among several events. Selected event type is used for configuring the schedule table. Up to 4 event types can be configured and each event type can be a combination of sensor, video loss and motion event.

- Pre-event Time
Specify the duration of recording before an event happens.
- Post-event Time
Specify the duration after the event is cleared

- Schedule Table

Actual recording mode is determined by **Schedule Table**, where recording mode configured by day (of a week) and hour.

Each of recording modes configures the recording operation as follows:

- Record Off
No recording in the schedule.
- Continuous
Recording continuously
- Disconnect
Recording is started when the system loses the connection to its last client (Decoder, VMS/NVR) etc. When there are multiple clients and one of the client is disconnected, this doesn't happen.
- Event Type
Records when an event configured in Event Type setting happens.

Disk Information

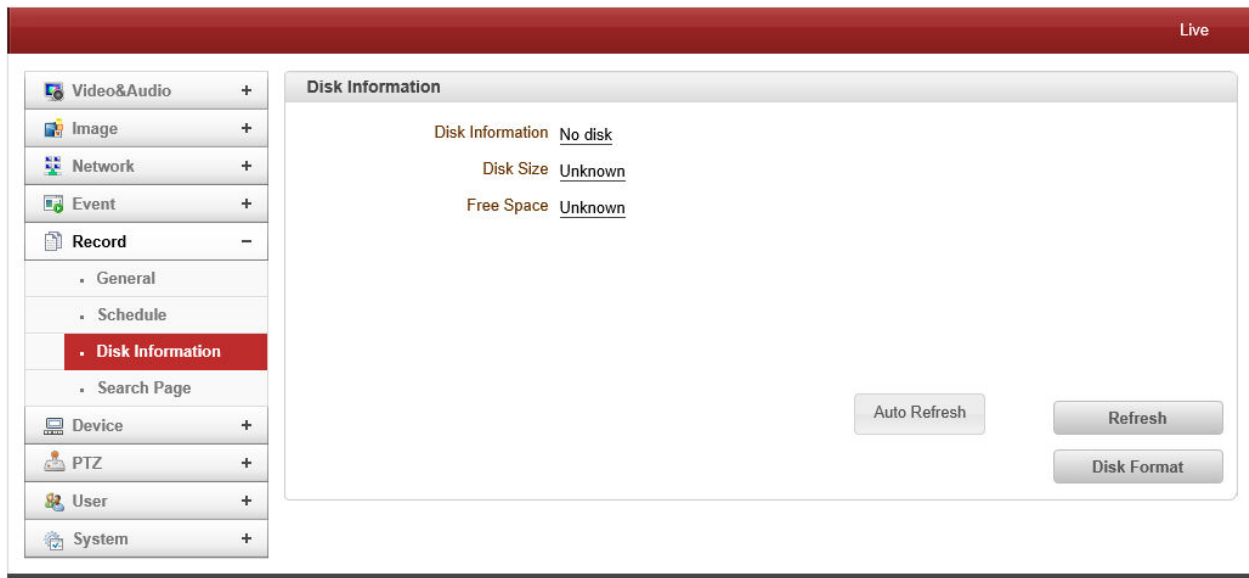

- USB memory stick or USB HDD can be used, and at least 1GB size is recommended. Either EXT3 or FAT32 file system can be used. A disk with either EXT3 or FAT32 file system can be read in Linux PC. However, only disk with FAT32 file system can be read in Windows PC. Less than 4Mbps of video bit rate is recommended when you record and monitor video simultaneously since frame dropping may happen due to performance limitation.
- Be sure to restart the system after connecting USB memory stick or USB HDD. During booting, the system reads status of disk and initializes it. Once the initialization of a disk is finished, the status of disk is shown on **Record** page of web-based setup Refer to the chart for checking the status of disk.

Disk status [↕]	Description [↕]
Disk error detected [↕]	Error [↕]
No disk [↕]	Disk is not connected to the system. [↕]
Searching Disk information [↕]	Checking the status of disk. Refresh the page and wait until the status is changed. [↕]
Mounting and [↕] Recovering Disk... [↕]	Performing recovery process when disk damage is found. It takes from seconds to minutes for recovering. [↕]
Disk format needed [↕]	Disk is attached, but the type of the file system is unknown or damaged. [↕]
Unknown disk type detected [↕]	
USB Disk available [↕]	Available to be used for recording [↕]
Disk removed [↕] or in abnormal state [↕]	Disk is detached during operation or there is damage on the file system. If it happens while disk is connected, it is recommended to format the disk. [↕]

Search Page

The screenshot shows a web interface with a sidebar on the left and a main content area on the right. The sidebar contains a menu with items: Video&Audio (+), Image (+), Network (+), Event (+), Record (-), General, Schedule, Disk Information, Search Page (highlighted in red), Device (+), PTZ (+), System (+), and User (+). The main content area is titled 'Search Page' and displays a search result for the date '2013_07_16'. Below the date, there are navigation icons and a count '(1)'. The date '2013_07_09' and '2012_10_29' are also visible in the header of the search results area.

- Recorded video and audio data can be saved as AVI or MP4 file format in the disk.

In general, one AVI file is created for an event in case of event-based recording. However, it is possible that recorded data by series of events happening continuously can be merged to a single AVI file depending on pre/post event time setting. The size of the file is limited to 10 ~ 2GB. In case of continuous recording, AVI files are created in series and the size of each is limited to 10 ~ 2GB.

This screenshot shows the same web interface as above, but with the search results expanded to show a file list. The path is 'Root >> 2013_07_16'. A 'Delete' button is visible above the file list. The file list has two columns: 'File Name' and 'Size'. There are two files listed:

<input type="checkbox"/>	File Name	Size
<input type="checkbox"/>	130716_065810_070019.avi	100.12M
<input type="checkbox"/>	130716_065603_065810.avi	100.60M

Navigation icons and a count '(1)' are shown below the file list.

- **Playback**

1. Selecting an AVI file will show a dialog for opening or saving the file

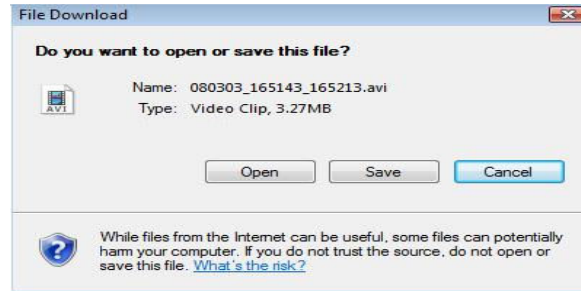

2. Pressing **Save** button, the file will be stored in the PC. The AVI file can be played with Windows Media Player.

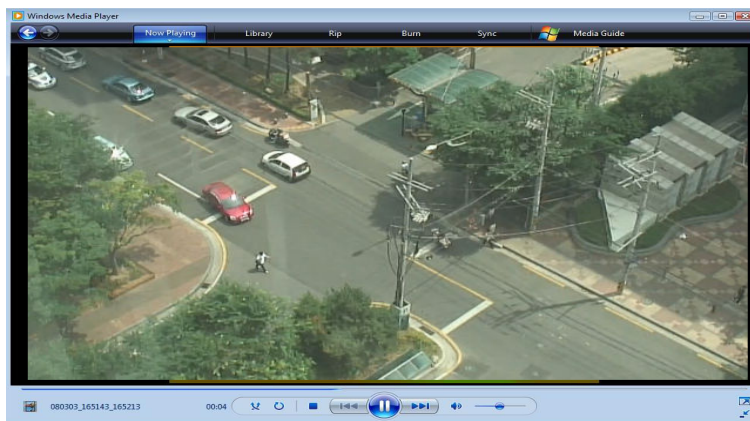

3. If you press **Open** in the dialog, the file will be downloaded and played automatically with Media Player.
4. Another connection through web is disabled during downloading and it is also not allowed to download two AVI files at the same time.

Device Information

Port	Tx (bps)	Rx (bps)
COM1	0	0
COM2	0	0

- The information provides current serial communication status.

Serial

COM1 (RS-232 Port)

- Protocol: RS-232
- Bitrate: 9600 bps
- Data Bit: 8 Bits
- Parity: None
- Stop Bit: 1 Bits
- Pass Through TCP Port: 0 (0=Disable)

COM2 (RS-422/485 Port)

- Protocol: RS-485
- Bitrate: 2400 bps
- Data Bit: 8 Bits
- Parity: None
- Stop Bit: 1 Bits
- Pass Through TCP Port: 0 (0=Disable)
- 485 Terminating Resistors: Off

Apply

- **Serial Protocol:** There are two serial ports, RS-232, RS-422/485 and select option accordingly.
- **Serial Port Configuration:** The serial ports can be configured as follows.

Each of the serial ports configurations must be same as the connecting device

PTZ

General

The screenshot shows a web-based configuration interface for PTZ settings. On the left is a sidebar menu with icons and labels for various system settings: Video&Audio, Image, Network, Event, Record, Device, PTZ, User, and System. The PTZ menu item is expanded, showing sub-items: General (highlighted in red), Preset, Group, Advanced, and Direction OSD. The main content area is titled 'PTZ' and contains three configuration fields: 'PTZ Type' with a dropdown menu set to 'Pelco-D', 'PTZ ID' with a text input field containing '1', and 'PTZ Port' with a dropdown menu set to 'COM2'. An 'Apply' button is positioned at the bottom right of the configuration area. A 'Live' indicator is visible in the top right corner of the interface.

- **PTZ Type**

Select the type of PTZ camera or receiver.

- **PTZ ID**

Since it is possible to control multiple PTZ cameras or receivers over a single control line, each camera or receiver will be assigned with a unique ID. Enter PTZ ID of a camera or receiver to control. The ID value range can be between 0 and 255.

- **PTZ Port**

Select the serial port for PTZ camera control.

Preset

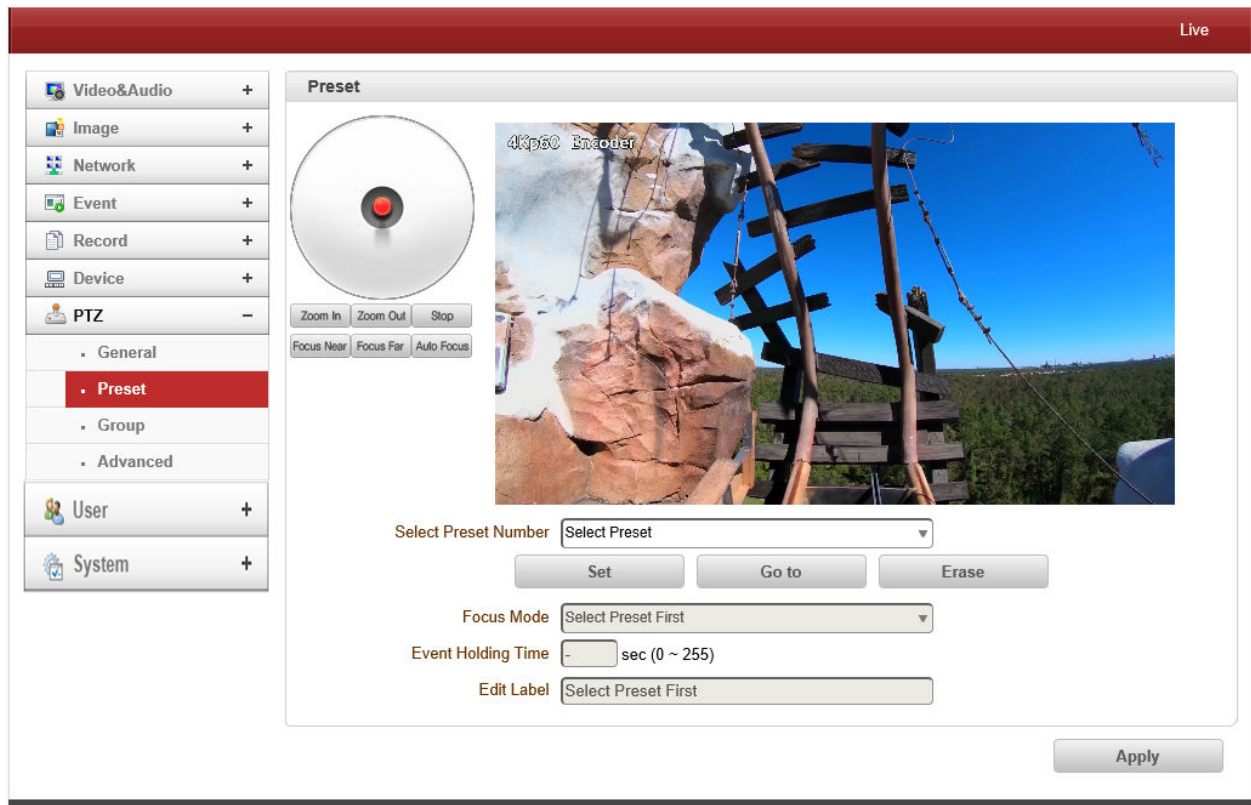

Max 500 preset positions can be defined.

- Select Preset Number: Select an entry in the list to be assigned to current camera position.
- Focus Mode: Select the focus mode after preset Goto is executed.
 - Do not change: current focus mode is not changed.
 - Focus Auto: auto-focusing is executed after the preset moves.
 - Focus Manual: move to the focus position saved when preset is set.
- Event Holding Time: Set the time to stay at the preset position when the preset moved by event.
 - If it is set to 0, the camera doesn't return to original position after moving to the preset position by event.**
- Edit Label: Assign a label to the preset position. Only the first 15 preset entries (Preset-1 ~ Preset-15) can have labels.

Group

No.	Action	Dwell Time(0-255)	Option(1~255)	Enable
1	No Preset	0 sec	Speed 255	<input type="checkbox"/>
2	No Preset	0 sec	Speed 255	<input type="checkbox"/>
3	No Preset	0 sec	Speed 255	<input type="checkbox"/>
4	No Preset	0 sec	Speed 255	<input type="checkbox"/>
5	No Preset	0 sec	Speed 255	<input type="checkbox"/>
6	No Preset	0 sec	Speed 255	<input type="checkbox"/>
7	No Preset	0 sec	Speed 255	<input type="checkbox"/>
8	No Preset	0 sec	Speed 255	<input type="checkbox"/>
9	No Preset	0 sec	Speed 255	<input type="checkbox"/>
10	No Preset	0 sec	Speed 255	<input type="checkbox"/>
11	No Preset	0 sec	Speed 255	<input type="checkbox"/>
12	No Preset	0 sec	Speed 255	<input type="checkbox"/>
13	No Preset	0 sec	Speed 255	<input type="checkbox"/>
14	No Preset	0 sec	Speed 255	<input type="checkbox"/>
15	No Preset	0 sec	Speed 255	<input type="checkbox"/>
16	No Preset	0 sec	Speed 255	<input type="checkbox"/>
17	No Preset	0 sec	Speed 255	<input type="checkbox"/>
18	No Preset	0 sec	Speed 255	<input type="checkbox"/>
19	No Preset	0 sec	Speed 255	<input type="checkbox"/>
20	No Preset	0 sec	Speed 255	<input type="checkbox"/>

- This function is that the camera memorizes the combination of Presets, Pattern and/or Swings sequentially and runs Presets, Pattern and/or Swings repetitively on activation. Max 8 groups are programmable. Each group can have a max of 20 actions which are the combinations of Preset, Pattern and Swing. Option field has different meanings for Preset and Pattern/Swing. For Preset, it configures the reset speed. For Pattern/Swing, it configures the number of repetition. Dwell time between actions can be set up as well.

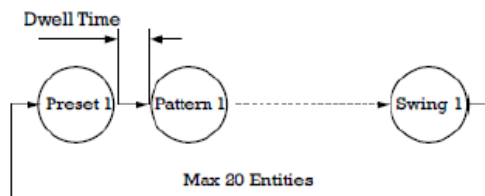

1. Select one of the entries of Group
2. Press Modify Group button. The following window will appear.
3. Set Action, Dwell Time and Option and click Enable squares
4. Press Apply button and the Group can be used on the Live View Page

Group							
#1	#2	#3	#4	#5	#6	#7	#8
No.	Action	Dwell Time(0~255)	Option(0~255)	Enable			
1	Preset-1	54 sec	Speed 77	<input checked="" type="checkbox"/>			
2	Preset-6	5 sec	Speed 124	<input checked="" type="checkbox"/>			
3	Preset-127	23 sec	Speed 55	<input checked="" type="checkbox"/>			
4	Preset-21	23 sec	Speed 43	<input checked="" type="checkbox"/>			
5	No Preset	0 sec	Speed 0	<input type="checkbox"/>			

Advanced

Live

- Video&Audio +
- Image +
- Network +
- Event +
- Record +
- Device +
- PTZ -
 - General
 - Preset
 - Group
 - Advanced
- User +
- System +

Advanced

Power Up Action Off Group-1 Preset-1 Preset-2 Preset-3

Motion Detection and Tampering disable on PTZ Off On

Auto Parking

Parking Time sec (0~3600, 0:0ff)

Parking Action #1

Parking Action #2

Parking Action #3

Parking Action #4

Schedule of Auto Parking

Parking Action #1
 Parking Action #2
 Parking Action #3
 Parking Action #4

	0	1	2	3	4	5	6	7	8	9	10	11	12	13	14	15	16	17	18	19	20	21	22	23
SUN																								
MON																								
TUE																								
WED																								
THU																								
FRI																								
SAT																								

- Power Up Action

Specify if the camera will continue previous action such as pattern, swing or group after it is rebooted by power.

- Group-1: When it will reboot, start to Group-1
- Preset-1: When it will reboot, start to Preset-1
- Off: Moves to the initial position after rebooting.

58/73

- **Motion Detection and Tampering disable on PTZ**

User can disable Motion detection and tampering on PTZ

- **Auto Parking**

Auto parking is a function to return to the previous preset position or to resume operation such as Pattern, Swing or Group when a specified time expires after user stopped PTZ control. Parking time can be set from 0 to 3600 seconds and "0" means that Auto Parking function is turned off.

Direct OSD (Only PT System)

The screenshot shows the 'Direction OSD' configuration window in the ANTRICA PTZ control software. The window is titled 'Direction OSD' and has a 'Live' indicator in the top right corner. On the left, there is a sidebar menu with various system settings, including 'PTZ' and 'Direction OSD'. The main area displays a live video feed of a stage performance with a red grid overlay. Below the video feed, there are several horizontal sliders for adjusting the OSD ranges. At the bottom, there is a table for configuring the OSD ranges.

	Enable	String	X-Coord (0-1000)	Y-Coord (0-1000)	Font Size (12-64)	Color
Range #1 - IN	<input type="checkbox"/>		0	0	30	White
Range #1 - OUT	<input type="checkbox"/>		0	0	30	White
Range #2 - IN	<input type="checkbox"/>		0	0	30	White
Range #2 - OUT	<input type="checkbox"/>		0	0	30	White
Range #3 - IN	<input type="checkbox"/>		0	0	30	White
Range #3 - OUT	<input type="checkbox"/>		0	0	30	White
Range #4 - IN	<input type="checkbox"/>		0	0	30	White
Range #4 - OUT	<input type="checkbox"/>		0	0	30	White

- 360 degrees panoramic shot
- User can select areas where to put in OSD

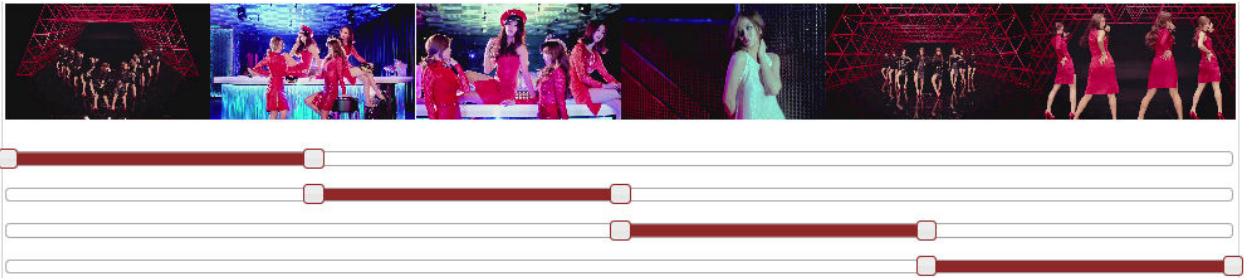

- Range # - In: According to coordinate value, user can see specific OSD.
- Range # - On: regardless of coordinate value, user can see specific OSD.
- X - Coord: Position of horizontal
- Y - Coord: Position of vertical
- Font size: Font size
- Hue: Color

User

User List

- User can be registered and privilege level of a user can be specified. User configuration is allowed only to admin user. Max 16 users can be registered and each user can have one of four privileges.

Privilege	Allowed Operations	Remarks
Admin	All operations	User ID = admin
Manager	All operations except for user configuration	
User	Live viewing and PTZ control	
Guest	Live viewing only	

- **Add User**

Press **Add** button. The following window will appear.

The 'Add User' dialog box contains the following fields and controls:

- ID**: Text input field
- Password**: Text input field
- Confirm Password**: Text input field
- Privilege Level**: Dropdown menu with 'Manager' selected
- Add**: Button
- Cancel**: Button

Enter User ID and password (Up to 15 characters) and select **Privilege Level**.

- **Delete User**

Select the User to be deleted and press **Delete** button.

- **Change Password**

Press **Modify Password** button. The following window will appear.

The 'Modify Password' dialog box contains the following fields and controls:

- ID**: Text input field with 'admin' pre-filled
- Current Password**: Text input field
- New Password**: Text input field
- Confirm Password**: Text input field
- Modify**: Button
- Cancel**: Button

Enter the current password and then set a new password.

- **Modify Privilege Level**

Press **Modify Privilege** button to change User level. It is not allowed to change the privilege level of admin user.

Modify Privilege Level ✕

ID

Privilege Level

Login Policy

Live

<ul style="list-style-type: none"> Video&Audio + Image + Network + Event + Record + Device + PTZ + User - <li style="padding-left: 20px;">User List <li style="padding-left: 20px; background-color: #f00; color: white;">Login Policy System + 	<div style="border: 1px solid gray; padding: 5px; margin-bottom: 5px;"> <p>Login Policy</p> <p>Authentication Type <input checked="" type="radio"/> Basic <input type="radio"/> Digest</p> <p>Skip Login <input checked="" type="radio"/> Off <input type="radio"/> On</p> <p>Privilege Level After Login Skipped <input style="border: 1px solid gray;" type="text" value="Admin"/> <input type="button" value="Apply"/></p> </div> <div style="border: 1px solid gray; padding: 5px; margin-bottom: 5px;"> <p>Authentication</p> <p>RTSP Authentication <input checked="" type="radio"/> Off <input type="radio"/> On</p> <p>HTTPAPI Authentication <input checked="" type="radio"/> Off <input type="radio"/> On <input type="button" value="Apply"/></p> </div> <div style="border: 1px solid gray; padding: 5px;"> <p>Login Failure Process</p> <p>Number of Login failures Allowed <input style="border: 1px solid gray;" type="text" value="No limit"/> <input type="button" value="Apply"/></p> </div>
--	---

- **Authentication Type**

HTTP authentication based on RFC 2617(HTTP Authentication: Basic and Digest Access Authentication) is supported.

- **Skip Login**

Skip Login provides for convenient access to the Video Server when authentication is not required. When Skip Login is set to **Enable**, login step is skipped.

- **Privilege Level After Login Skipped**

The privilege level after login in this way is determined by the setting of **Privilege Level After Login Skipped**. If Privilege Level After Login Skipped is set as user, login in is not needed for user level's authority.

Authentication

RTSP and HTTPAPI Authentication can be selected when client try to connect Video Server.

Login Failure Process

- **Number of Login failures Allowed**

Number of login failures is selected from no limit to 10 times and E-mail notification is available as well.

Once number of login is full as selected, User ID is blocked as selected from 30 seconds to 5 minute.

System

Information

The screenshot shows a web interface with a red header bar containing the word "Live". On the left is a navigation menu with icons and labels: Video&Audio, Image, Network, Event, Record, Device, PTZ, User, System, Information (highlighted in red), Upgrade&Reboot, Time, OSD, Language, and Log. The main content area is titled "System Information" and displays the following details:

Model	ANT-35100A (4001)
IP FW Version	V15.403B07_T913
ONVIF Version	21.12
OpenSSL Version	OpenSSL 1.1.1j 16 Feb 2021
MAC Address	00:1C:63:D9:00:25
IP Address	192.168.10.100
Domain Name	Not RegisteredB

- System information

Followed network information is displayed (Read only)

- **Model**

Display the model name.

- **Version**

Display the current firmware version.

- **ONVIF Version**

Display the current Onvif version.

- **OpenSSL Version**

Display the current OpenSSL Version.

- **Mac Address**
Display the MAC address of the camera. In case the camera is registered at DDNS server, the MAC address is used in DDNS registration.
- **Current Domain**
In case the camera is registered at DDNS server, the registered domain name is displayed.
- **RCV Version**
Display HDMI receiver chip version.

Upgrade & Reboot

- **Firmware**
- Version : Display the current firmware version

Upgrade: To upgrade firmware;

1. Press **Browse** button to select a firmware file from PC.
2. Press **Firmware Upgrade** button to start upgrading.
3. A message for showing status (downloading / upgrading) will be displayed.
4. The camera will reboot automatically after completing upgrade.

Do not turn the camera off during upgrading.

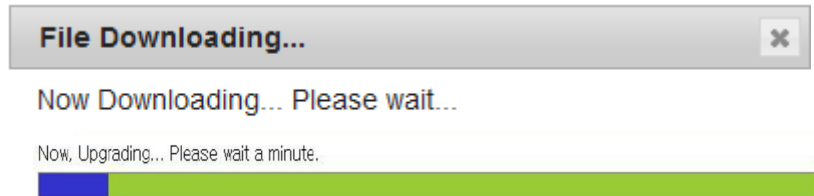

- **Config Backup & Restore**

- Backup

All the setting of configuration can be stored.

- Restore

Stored configuration can be browsed and restored. The server is rebooted once **Config Restore** button is pressed.

- **Reboot**

- Reboot the camera

Do not press the Reboot button unless the server needs a reboot.

- **Factory Reset**

All settings including user accounts and logs are cleared. Also user can select option (Network, Preset, User List) that excluded after factory reset.

- **SSL Certificates Upload**

Crt File and Key File are uploaded for SSL (Secure Sockets Layer) Certificate file.

Time

- **Start Time**

The latest the camera's booting date and time.

- **Current Time**

Current date and time.

Enter a new date and time then press **Set Current Time** button to update date & time.

- **Time Format**

Change the time format. The selectable time formats are as below;

- I. YYYY/MM/DD hh:mm:ss (Eg. 2012/10.30 12:30:45)
- II. DD/MM/YYYY hh:mm:ss (Eg. 10/30/2012 12:30:45)
- III. MM/DD/YYYY hh:mm:ss (Eg. 30/10/2012 12:30:45)

- **Time Zone**

Select time zone of where the camera is installed.

Depending on the time zone, Daylight Saving Time will work automatically

A **time zone** is a region of the earth that has uniform standard time, usually referred to as the **local time**. By convention, time zones compute their local time as an offset from UTC (Coordinated Universal Time). In casual use, GMT (Greenwich Mean Time) can be considered equivalent to UTC. Local time is UTC plus the current time zone offset for the considered location

- **Automatically synchronized with NTP server**

Synchronize the camera time with an NTP server using NTP (network time protocol).

Name of the NTP server should be registered on NTP server Name.

The **Network Time Protocol (NTP)** is a protocol for synchronizing the clocks of computer systems over packet-switched, variable-latency data networks. It is designed particularly to resist the effects of variable latency by using a jitter buffer.

OSD

Live

- Video&Audio +
- Image +
- Network +
- Event +
- Record +
- Device +
- PTZ +
- User +
- System -**
 - Information
 - Upgrade&Reboot
 - Time
 - OSD**
 - Language
 - System Mode
 - Log

System ID

System ID

Web Viewer OSD

System ID Off On

Time Off On

Position Bottom Top

Burn-in OSD

System ID Off On

Time Off On

Position Bottom Top

Font Size

User-defined Burn-in OSD

No.	String	X-Coord (0~1000)	Y-Coord (0~1000)	Font Size (12~84)	Color	Enable
1	<input type="text"/>	<input type="text" value="0"/>	<input type="text" value="0"/>	<input type="text" value="30"/>	White	<input type="checkbox"/>
2	<input type="text"/>	<input type="text" value="0"/>	<input type="text" value="0"/>	<input type="text" value="30"/>	White	<input type="checkbox"/>
3	<input type="text"/>	<input type="text" value="0"/>	<input type="text" value="0"/>	<input type="text" value="30"/>	White	<input type="checkbox"/>
4	<input type="text"/>	<input type="text" value="0"/>	<input type="text" value="0"/>	<input type="text" value="30"/>	White	<input type="checkbox"/>

User-defined Bitmap OSD

OSD Enable

- System ID

Enter System ID that is used as a Video Server name.

The set System ID is displayed with video image on a Web Browser. The System ID is also transferred to remote software, such as VMS, and displayed on it.

- BurnIn OSD

Insert system ID and date/time in the compressed video. System ID and time respectively can be turned on or off in the video. Position and Font size can be configured also. System ID for BurnIn OSD exists independently from normal System ID.

Note that size of Burnin OSD display varies according to the encoding resolution setting. This is inevitable because Burnin OSD is inserted to the frames before encoding is performed. The following table describes the rule for BurnIn OSD display.

Resolution [↕]	Small (8x8) [↕]	Middle (16x16) [↕]	Large (32x32) [↕]
352x480 / 352x240 / 352x576 / 352x288 [↕]	2 [↕]	1 [↕]	0 [↕]
720x480 / 720x240 / 720x576 / 720x288 / [↕] 640x480 / 800x600 [↕]	2 [↕]	2 [↕]	1 [↕]
1024 x 768 / 1280x720 / 1280 x 960 / 1280x1024 / 1440x900 / 1600x900 / 1680x1050 / 1920x1056 / 1920x1080 / 2048x1536 / 2560x1600 / 2592x1936 [↕]	2 [↕]	2 [↕]	2 [↕]

- 2 : Both System ID and Time are displayed
- 1 : Either System ID or Time can be displayed. When both are enabled, System ID is displayed.
- 0 : No items are displayed. This is because video area is too small to display OSD text in large text.

- **User defined OSD**
You can enter any text you like independent.
- X-Coordinate or Y-Coordinate
For example, if you enter 500, 500 values, OSD is placed in center of images.
- **User-defined Bitmap OSD**
OSD could be enabled or disabled while Bitmap image is uploaded in the video. X-Coordinate or Y-Coordinate can be adjusted according to values. Bitmap image could be uploaded.

Language

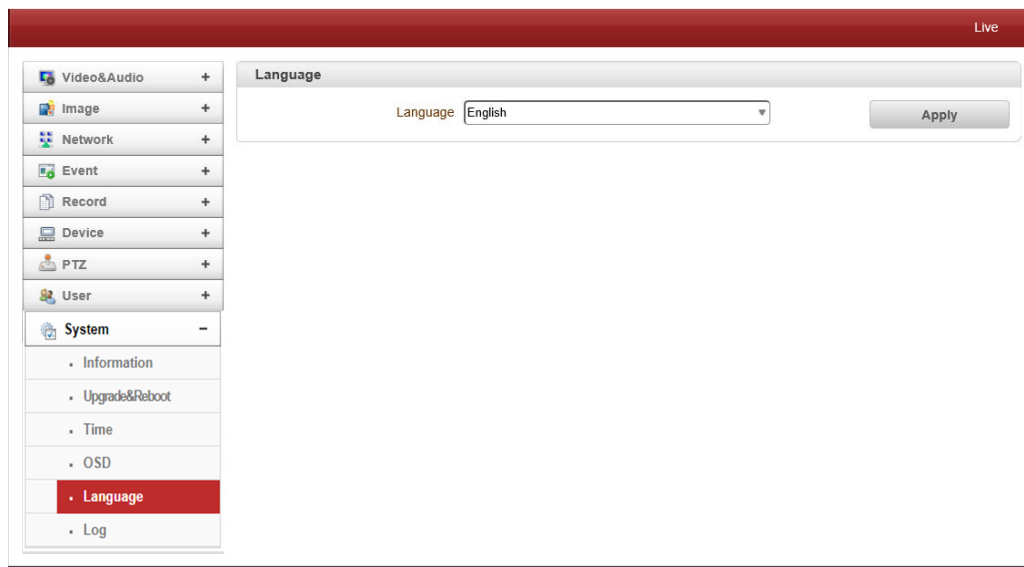

- **Language**
Select the language to be used for web-based configuration.

Log

The screenshot displays the 'Log' interface with a sidebar on the left containing menu items: Video&Audio, Image, Network, Event, Record, Device, PTZ, User, System, and System (with sub-items: Information, Upgrade&Reboot, Time, OSD, Language, and Log). The main area is divided into three sections:

- System Log:** A scrollable list of log entries. Each entry includes a timestamp, a status (e.g., CONNECTION), a level (Normal), and a description (e.g., Connected IP(192.168.128.19)). Below the list is a filter bar with checkboxes for Backup, Account, Environment, System, PTZ, Etc, and Connection. Buttons for 'Get System Log', 'Save System Log', and 'Delete System Log File' are present.
- User Log:** A scrollable list of user login events. Each entry includes a timestamp, a status (USER Login), a result (success or failure), a user ID (ID(admin)), and an IP address (e.g., IP(192.168.128.19)). Buttons for 'Get User Log', 'Save User Log', and 'Delete User Log File' are present.
- Save Log Option:** A table with two columns: 'Include' and 'Exclude'. It lists various log categories with radio buttons to select inclusion or exclusion.

	Include	Exclude
User	<input checked="" type="radio"/>	<input type="radio"/>
Backup	<input checked="" type="radio"/>	<input type="radio"/>
Account	<input checked="" type="radio"/>	<input type="radio"/>
Environment	<input checked="" type="radio"/>	<input type="radio"/>
System	<input checked="" type="radio"/>	<input type="radio"/>
PTZ	<input checked="" type="radio"/>	<input type="radio"/>
Etc	<input checked="" type="radio"/>	<input type="radio"/>
Connection	<input checked="" type="radio"/>	<input type="radio"/>

 An 'Apply' button is located at the bottom right of this section.

System Mode

Video Server's log can be shown and saved as txt file. Various filters could be selected.

User Log

User (Client) log can be shown and saved as txt file.

Save Log Option

Various options can be included or excluded.

Appendix A : Sensor and Alarm Port

Sensor Port

- **Terminal Type**
 - Color : Green
- **Sensor Signal Input Type**
 - NO Contact Signals
- **Connection to External Device (Using switch)**

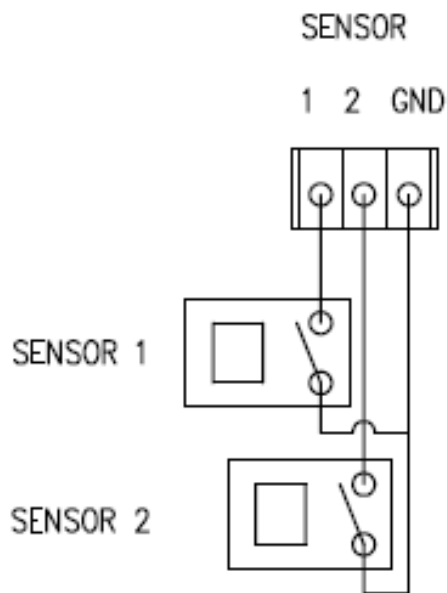

Alarm Port

- **Power Rating (User has to use following spec)**

- Voltage Rating: 12VDC
- Current Rating : 0.1A

- **Alarm Signal Output Type**

- NO/NC Contact Signals

- **Connection to External Device**

External alarm line power is under 12V/0.1A

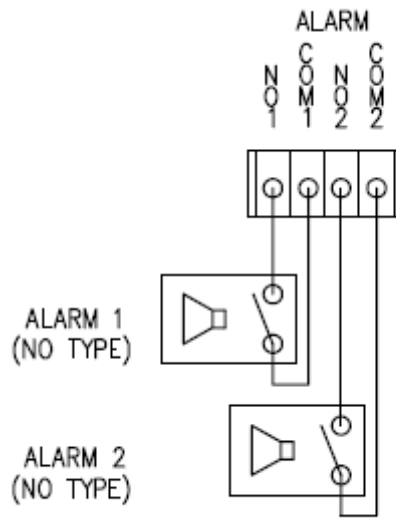

External alarm line power is over 12V/0.1A

